

Operating Instructions

CD CDV LD PLAYER

LaserDisc

CLD-D503

CLD-D570

NTSC

COMPACT
disc
DIGITAL AUDIO

L
LASER DISC

- This player does not apply to business use.
- CD-ROM, LD-ROM and CD graphic discs cannot be played with this player.

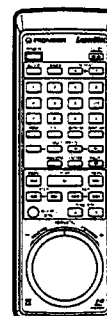
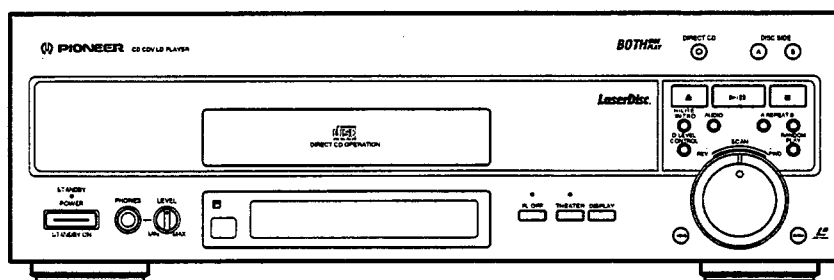

Thank you for buying this Pioneer product. Please read through these operating instructions so you will know how to operate your model properly. After you have finished reading the instructions, put them away in a safe place for future reference. In some countries or regions, the shape of the power plug and power outlet may sometimes differ from that shown in the explanatory drawings. However, the method of connecting and operating the unit is the same.

WARNING: TO PREVENT FIRE OR SHOCK HAZARD, DO NOT EXPOSE THIS APPLIANCE TO RAIN OR MOISTURE.

IMPORTANT NOTICE

[For U.S. and Canadian models]

The serial number for this equipment is located on the rear panel. Please write this serial number on your enclosed warranty card and keep it in a secure area. This is for your security.

[For Canadian model]

CAUTION: TO PREVENT ELECTRIC SHOCK DO NOT USE THIS (POLARIZED) PLUG WITH AN EXTENSION CORD, RECEPTACLE OR OTHER OUTLET UNLESS THE BLADES CAN BE FULLY INSERTED TO PREVENT BLADE EXPOSURE.

ATTENTION: POUR PREVENIR LES CHOCS ELECTRIQUES NE PAS UTILISER CETTE FICHE POLARISEE AVEC UN PROLONGATEUR, UNE PRISE DE COURANT OU UNE AUTRE SORTIE DE COURANT, SAUF SI LES LAMES PEUVENT ETRE INSEREES A FOND SANS EN LAISSER AUCUNE PARTIE A DECOUVERT.

LINE VOLTAGE SELECTOR SWITCH

Only multi-voltage models are provided with this switch. U.S. and Canadian models are not provided with this switch.

The line voltage selector switch is located on the rear panel of this player. Before your player is shipped from the factory, the switch is set to the power requirements of the player's destination. Check that it is set properly before plugging the power cord into the outlet. If the voltage is not properly set or if you move to an area where the voltage requirements differ, adjust the selector switch as follows: Use a medium-sized (flat blade) screwdriver. Insert the tip of the screwdriver into the groove of the selector switch and turn it to set the player to the power voltage of your area.

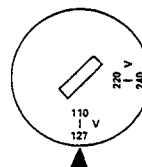

Set the selector so the arrow points to power voltage of your area (Figure shows arrow pointing to 110 - 127 v(olts).)

CAUTION:

This product satisfies FCC regulations when shielded cables and connectors are used to connect the unit to other equipment. To prevent electromagnetic interference with electric appliances such as radios and televisions, use shielded cables and connectors for connections.

PIONEER
The Art of Entertainment

IMPORTANT



The lightning flash with arrowhead, within an equilateral triangle, is intended to alert the user to the presence of uninsulated "dangerous voltage" within the product's enclosure that may be of sufficient magnitude to constitute a risk of electric shock to persons.

CAUTION

RISK OF ELECTRIC SHOCK
DO NOT OPEN



The exclamation point within an equilateral triangle is intended to alert the user to the presence of important operating and maintenance (servicing) instructions in the literature accompanying the appliance.

CAUTION:
TO PREVENT THE RISK OF ELECTRIC SHOCK, DO NOT REMOVE COVER (OR BACK). NO USER-SERVICEABLE PARTS INSIDE. REFER SERVICING TO QUALIFIED SERVICE PERSONNEL.

SAFETY INSTRUCTIONS

READ INSTRUCTIONS – All the safety and operating instructions should be read before the appliance is operated.

RETAIN INSTRUCTIONS – The safety and operating instructions should be retained for future reference.

HEED WARNINGS – All warnings on the appliance and in the operating instructions should be adhered to.

FOLLOW INSTRUCTIONS – All operating and use instructions should be followed.

CLEANING – Unplug this video product from the wall outlet before cleaning. Do not use liquid cleaners or aerosol cleaners. Use a damp cloth for cleaning.

ATTACHMENTS – Do not use attachments not recommended by the video product manufacturer as they may cause hazards.

WATER AND MOISTURE – Do not use this video product near water – for example, near a bathtub, wash bowl, kitchen sink, or laundry tub, in a wet basement, or near a swimming pool, etc.

ACCESSORIES – Do not place this video product on an unstable cart, stand, tripod, bracket, or table. The video product may fall, causing serious injury to a child or adult, and serious damage to the appliance. Use only with a cart, stand, tripod, bracket, or table recommended by the manufacturer, or sold with the video product. Any mounting of the appliance should follow the manufacturer's instructions, and should use a mounting accessory recommended by the manufacturer.

CART – An appliance and cart combination should be moved with care. Quick stops, excessive force, and uneven surfaces may cause the appliance and cart combination to overturn.



VENTILATION – Slots and openings in the cabinet are provided for ventilation and to ensure reliable operation of the video product and to protect it from overheating. These openings must not be blocked or covered. They should never be blocked by placing the video product on a bed, sofa, rug, or other similar surface. This video product should never be placed near or over a radiator or heat register. This video product should not be placed in a built-in installation such as a bookcase or rack unless proper ventilation is provided or the manufacturer's instructions have been adhered to.

POWER SOURCES – This video product should be operated only from the type of power source indicated on the marking label. If you are not sure of the type of power supply to your home, consult your appliance dealer or local power company. For video products intended to operate from battery power, or other sources, refer to the operating instructions.

POWER-CORD PROTECTION

Power-supply cords should be routed so that they are not likely to be walked on or pinched by items placed upon or against them. Pay particular attention to cords at plugs, convenience receptacles, and the point where they exit from the appliance.

POLARIZATION – This video product is equipped with a polarized alternating current line plug (a plug having one blade wider than the other). This plug will fit into the power outlet only one way. This is a safety feature. If you are unable to insert the plug fully into the outlet, try reversing the plug. If the plug should still fail to fit, contact your electrician to replace your obsolete outlet. Do not defeat the safety purpose of the polarized plug.

LIGHTNING – For added protection for this video product receiver during a lightning storm, or when it is left unattended and unused for long periods of time, unplug it from the wall outlet and disconnect the antenna or cable system. This will prevent damage to the video product due to lightning and power-line surges.

POWER LINES – An outside antenna system should not be located in the vicinity of overhead power lines or other electric light or power circuits, or where it can fall into such power lines or circuits. When installing an outside antenna system, extreme care should be taken to keep from touching such power lines or circuits as contact with them might be fatal.

OVERLOADING – Do not overload wall outlets and extension cords as this can result in the risk of fire or electric shock.

OBJECT AND LIQUID ENTRY – Never push objects of any kind into this video product through openings as they may touch dangerous voltage points or short-out parts that could result in a fire or electric shock. Never spill liquid of any kind on the video product.

SERVICING – Do not attempt to service this video product yourself as opening or removing covers may expose you to dangerous voltage or other hazards. Refer all servicing to qualified service personnel.

DAMAGE REQUIRING SERVICE

Unplug this video product from the wall outlet and refer servicing to qualified service personnel under the following conditions:

- When the power-supply cord or plug is damaged.
- If liquid has been spilled, or objects have fallen into the video product.
- If the video product has been exposed to rain or water.
- If the video product does not operate normally by following the operating instructions. Adjust only those controls that are covered by the operating instructions. Improper adjustment of other controls may result in damage and will often require extensive work by a qualified technician to restore the video product to its normal operation.
- If the video product has been dropped or the cabinet has been damaged.
- When the video product exhibits a distinct change in performance – this indicates a need for service.

REPLACEMENT PARTS – When replacement parts are required, be sure the service technician has used replacement parts specified by the manufacturer or having the same characteristics as the original part. Unauthorized substitutions may result in fire, electric shock or other hazards.

SAFETY CHECK – Upon completion of any service or repairs to this video product, ask the service technician to perform safety checks to determine that the video product is in proper operating condition.

OUTDOOR ANTENNA GROUNDING – If an outside antenna is connected to the antenna terminal, be sure the antenna system is grounded so as to provide some protection against voltage surges and built-up static charges.

In the U.S.A. section 810 of the National Electrical Code, ANSI/NFPA 70, provides information with respect to proper grounding of the mast and supporting structure, grounding of the lead-in wire to an antenna discharge unit, size of grounding conductors, location of antenna-discharge unit, connection to grounding electrodes, and requirements for the grounding electrode.

See Fig. A.

NEC – NATIONAL ELECTRIC CODE

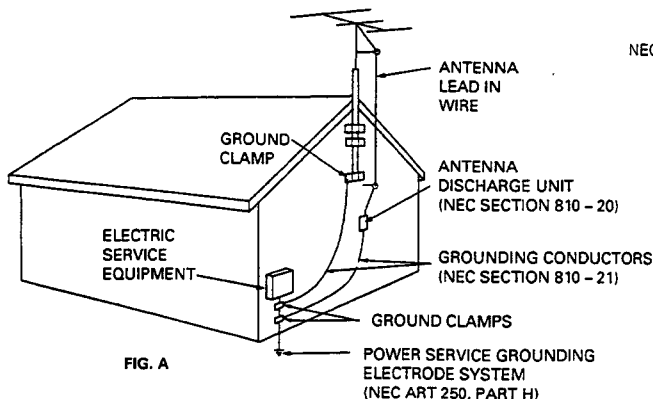

FIG. A

CAUTION

- Use of controls or adjustments or performance of procedures other than those specified herein may result in hazardous radiation exposure.
- The use of optical instruments with this product will increase eye hazard.

Information to User

Alteration or modifications carried out without appropriate authorization may invalidate the user's right to operate the equipment.

This equipment has been tested and found to comply with the limits for a Class B digital device, pursuant to Part 15 of the FCC Rules. These limits are designed to provide reasonable protection against harmful interference in a residential installation. This equipment generates, uses, and can radiate radio frequency energy and, if not installed and used in accordance with the instructions, may cause harmful interference to radio communications. However, there is no guarantee that interference will not occur in a particular installation. If this equipment does cause harmful interference to radio or television reception, which can be determined by turning the equipment off and on, the user is encouraged to try to correct the interference by one or more of the following measures:

- Reorient or relocate the receiving antenna.
- Increase the separation between the equipment and receiver.
- Connect the equipment into an outlet on a circuit different from that to which the receiver is connected.
- Consult the dealer or an experienced radio/TV technician for help.

- This player may be used with LaserVision Discs, Compact Discs, and Compact Discs with Video bearing the following symbols:

(LASERDISC SYSTEM)/(LaserVision Disc)*



This is the unified symbol mark of LASERDISC (LaserVision videodisc).

* LaserVision players and discs which bear this symbol and use the same television system, are mutually compatible.

(Compact Disc)



(**CD VIDEO SYSTEM)



(3-inch Compact Disc)



** Digital Audio with Multi Audio Discs (CD VIDEO LD) and a CDV (CD Video CDV) are referred to as CD Video discs. CD Video discs are recorded with subcodes, which are the non-audio recordings of TOC data such as track numbers, index numbers, etc. However, there are some discs without these marks.

[For Canadian model]

This digital apparatus does not exceed the Class B limits for radio noise emissions from digital apparatus set out in the Radio Interference Regulations of the Canadian Department of Communications.

Only one disc can be loaded at any one time. Loading a LaserVision Disc, a Compact Disc, a 3-inch Compact Disc or a Compact Disc with Video on top of one another may result in breakdown, or in scratching of the discs. Please only load one disc at a time.

This player is to be used exclusively with the NTSC color system. Please use NTSC LaserVision Disc or NTSC Compact Disc with Video only. PAL and SECAM system discs cannot be used with this player.



Dear Customer:

Selecting fine audio equipment such as the unit you've just purchased is only the start of your musical enjoyment. Now it's time to consider how you can maximize the fun and excitement your equipment offers. This manufacturer and the Electronic Industries Association's Consumer Electronics Group want you to get the most out of your equipment by playing it at a safe level. One that lets the sound come through loud and clear without annoying blaring or distortion-and, most importantly, without affecting your sensitive hearing.

Sound can be deceiving. Over time your hearing "comfort level" adapts to higher volumes of sound. So what sounds "normal" can actually be loud and harmful to your hearing. Guard against this by setting your equipment at a safe level BEFORE your hearing adapts.

To establish a safe level:

- Start your volume control at a low setting.
- Slowly increase the sound until you can hear it comfortably and clearly, and without distortion.

Once you have established a comfortable sound level:

- Set the dial and leave it there.

Taking a minute to do this now will help to prevent hearing damage or loss in the future. After all, we want you listening for a lifetime.

We Want You Listening For A Lifetime

Used wisely, your new sound equipment will provide a lifetime of fun and enjoyment. Since hearing damage from loud noise is often undetectable until it is too late, this manufacturer and the Electronic Industries Association's Consumer Electronics Group recommend you avoid prolonged exposure to excessive noise. This list of sound levels is included for your protection.

Decibel

Level	Example
30	Quiet library, soft whispers
40	Living room, refrigerator, bedroom away from traffic
50	Light traffic, normal conversation, quiet office
60	Air conditioner at 20 feet, sewing machine
70	Vacuum cleaner, hair dryer, noisy restaurant
80	Average city traffic, garbage disposals, alarm clock at two feet.

THE FOLLOWING NOISES CAN BE DANGEROUS UNDER CONSTANT EXPOSURE

90	Subway, motorcycle, truck traffic, lawn mower
100	Garbage truck, chain saw, pneumatic drill
120	Rock band concert in front of speakers, thunderclap
140	Gunshot blast, jet plane
180	Rocket launching pad

Information courtesy of the Deafness Research Foundation.



CONTENTS

<p>ACCESSORIES 5</p> <p>PRECAUTIONS 6</p> <p>FEATURES AND FUNCTIONS OF THE PLAYER 7</p> <p>TYPES OF DISCS THAT CAN BE PLAYED WITH THIS UNIT 8</p> <p>CARE OF DISCS 10</p> <p>CONNECTIONS 11</p> <p>NAMES AND FUNCTIONS OF REMOTE CONTROL UNIT COMPONENTS 15</p> <p>NAMES AND FUNCTIONS OF FRONT PANEL COMPONENTS 16</p> <p>TO PLAY AN LD, CDV OR CD 18</p> <p>PARTICULAR FUNCTIONS FOR CD (Direct CD) 22</p> <p>TO ADJUST THE SOUND VOLUME (Digital Level Control) 22</p> <p>WATCHING A MOVIE DISC (Theater Mode) 23</p> <p>TO SEARCH FOR A PARTICULAR PASSAGE (High Speed Scan) 23</p> <p>TO SEARCH FOR A PARTICULAR CHAPTER/TRACK (Hi-Lite Scan/Intro Scan) 24</p>	<p>TO SEARCH FOR A PARTICULAR CHAPTER/TRACK (Chapter (Track) Search/Chapter (Track) Skip) 25</p> <p>TO SEARCH FOR A PARTICULAR TIME/FRAME (Time Number Search/Track Time Search/ABS Time Search/Frame Number Search) 26</p> <p>TO PLAY ALL CHAPTERS/TRACKS IN A RANDOM ORDER (Random Playback) 27</p> <p>TO REPEATEDLY PLAY A DESIRED PASSAGE (Repeat Playback) 28</p> <p>TO PLAY ONLY DESIRED SCENES/TRACKS (Program Playback) 30</p> <p>PROGRAMMING CHAPTERS/TRACKS TO BE PLAYED BACK WITHIN A SPECIFIED TIME PERIOD (Compu Program/Auto Program Edit) 32</p> <p>EXTRA PLAYBACK 33</p> <p>DISPLAY SWITCHING 34</p> <p>TROUBLESHOOTING 36</p> <p>SPECIFICATIONS 39</p>
--	---

ACCESSORIES

When unpacking the player, first check to make sure that all of the accessories listed below are supplied.

- Remote control unit
- Size "AAA" (IEC R03) dry cell battery x 2

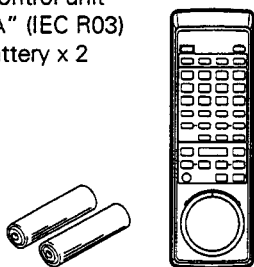

- Video cord (Pin plug ↔ Pin plug)
Use to connect the player to a color monitor etc.

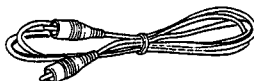

- Audio cord (Pin plug x 2 ↔ Pin plug x 2)
Use to connect the player to a stereo amplifier etc.



- Operating instructions
- Warranty card

INSERTING BATTERIES INTO THE REMOTE CONTROL UNIT

- 1 Open the battery compartment cover on the back of the remote control unit. The cover should open easily if you press on in with your thumb while sliding it in the direction of the arrow.
- 2 Take out the two accessory size "AAA" (IEC R03) dry cell batteries, and insert them into the battery compartment in accordance with the display (⊕, ⊖) inside the compartment.
- 3 Close the cover of the battery case.

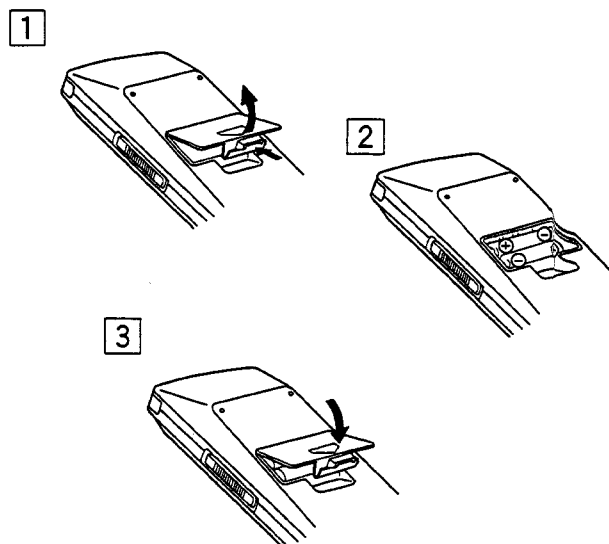

Incorrect use of batteries may cause leakage or rupture. Always be sure to follow these guidelines:

- A. Always insert batteries into the battery compartment correctly matching the positive ⊕ and negative ⊖ polarities, as shown by the display inside the compartment.
- B. Never mix new and used batteries.
- C. Batteries of the same size may have different voltages, depending on brand. Do not mix different brands of batteries.

PRECAUTIONS

If it becomes necessary to transport or ship this unit in the future, be sure to first remove the disc (if loaded), retract the disc table to its closed position and turn the power off. After the "OFF" display goes out on the display, disconnect the power cord.

INSTALLING THE PLAYER

- Place the player on a stable platform next to the television and stereo system to be used with the player.
- When using the player with a stereo system, your speakers should be placed away from your television (or TV monitor).
- Do not place heavy objects such as a television or TV monitor on top of the player.
- Do not place the player on top of your TV set or TV monitor. Also, keep the player away from devices such as cassette decks which are sensitive to magnetic fields.

When FM or AM stations are being received, signal noise may be generated if the player is turned on. Turn off the player when not in use. Also, if there is signal noise when receiving radio stations with an indoor antenna, adjust the position or direction of the antenna.

INSTALL THE PLAYER IN A WELL VENTILATED PLACE AWAY FROM HEAT AND HUMIDITY

Do not install the player in a location subject to direct sunlight, or near a stove or radiator etc. This could adversely affect the cabinet and internal components. Also avoid installing the player in a humid or dusty location. This could result in a malfunction or accident. Do not install near a cookstove where the player could be affected by smoke, steam, or heat.

AVOID SOURCES OF HEAT

Do not put the player on sources of heat, such as an amplifier. When installing with audio components on a rack, avoid components that generate heat, by placing the player below such components where there is adequate ventilation and not much dust. Avoid placing the player on surfaces such as shaggy carpets, beds, and sofas which may block ventilation under the player and cause damage.

CAUTIONS FOR AUTOMATIC LOADING OPERATIONS

Since this player has an automatic loading construction, use the button on the player or the remote control unit for opening and closing of the disc table. To avoid damage, be careful not to apply any force to the moving disc table.

Even when the player is in the pause mode, the disc-drive motor is still revolving. Since leaving the player in this condition can shorten the lifetime of the motor, do not leave the player in the pause mode for long periods of time. Also, to prevent the damage to the screen, do not use the unit for long periods of time under conditions in which the screen display (monitor) has been displayed characters (for example, power-ON mode, CD PLAY, PAUSE)

Take the following precautions to avoid accidents!

Be careful not to catch your finger in the disc table section while the disc table is being retracted into the unit. Also, be careful that children do not put their hands into the inside of the unit while the disc table is open. This may cause injury.

STRIPE PATTERNS APPEARING ON A TV PROGRAM

Stripe patterns may appear during a TV program if the player unit is turned on, depending on the quality of reception of the TV station. This is neither a malfunction of the television nor the player. If stripes appear while watching the TV, or when watching the TV for long periods of time, turn the player off.

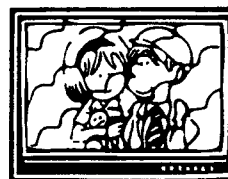

CONDENSATION

Moisture will form in the operating section of the player if the player is brought from cool surroundings into a warm room or if the temperature of the room rises suddenly. When this happens, player's performance will be impaired.

To prevent this, let the player stand in its new surroundings for about an hour before switching it on, or make sure that the room temperature rises gradually.

The same, symptoms of condensation may be caused during summer, if the player is exposed to the breeze from an air conditioner. In such cases change the location of the player.

POWER-CORD CAUTION

Handle the power cord by the plug. Do not pull out the plug by tugging the cord and never touch the power cord when your hands are wet as this could cause a short circuit or electric shock. Do not place the unit, a piece of furniture, etc., on the power cord, or pinch the cord. Never make a knot in the cord or tie it with other cords. The power cords should be routed such that they are not likely to be stepped on. A damaged power cord can cause fire or give you an electrical shock. Check the power cord once in a while. When you find it damaged, ask your nearest PIONEER authorized service center or your dealer for a replacement.

CLEANING CARE

Use a soft, dry cloth for cleaning. For stubborn dirt, soak the cloth in a solution of household detergent diluted using 1 part detergent to five or six parts water; wring well first and wipe. Use a dry cloth to wipe it dry. Do not use any volatile agents such as benzine or paint thinner, as they may damage the surface of the player.

Abnormal functioning of this unit may be caused by lightning, static electricity, other external interference. To restore normal operation, unplug the AC power cord and then plug it in again.

FEATURES AND FUNCTIONS OF THE PLAYER

Playback Functions

Program Playback

Up to 24 chapters can be programmed for playback in any desired sequence.

Random Playback (For LDs, this function is available with only discs containing TOC.)

All chapters of one side of a disc can be played in random order.

Repeat Playback

Eight repeat modes - Memory Repeat, A-B Repeat, 1-chapter/track Repeat, One-side Repeat, All side Repeat (for two-side LDs only), Program Repeat, Random Repeat and Program Random Repeat - are available. (With discs having no TOC, Random Repeat cannot be carried out.)

Hi-Lite/Intro Scan Playback

Hi-Lite Scan - CD, CDV-audio part

Playback starts from a point 1 minute after the beginning of the track, and each track is played for about 8 seconds. Also, Hi-Lite Scan playback can be started from the desired minute and second on each track.

Intro Scan - LD, CDV-video part

The beginning of each chapter/track is played for about 8 seconds.

Auto Program Editing/Compu Program Editing

The player automatically selects and programs the tracks which can be played back within a specified time.

LD (LaserDisc) Playback Functions

Gamma-Turn System - Two-Side Continuous Playback

With this function, both sides of a two-sided LD can be played consecutively, eliminating the need to turn the disc over when the first side is completed.

A Side ↔ B Side Continuous Playback Programs

Through the use of the Gamma-Turn system, programs which go from side A to side B or from side B to side A can be freely created.

Last Memory Function

With this function, if you turn the power switch off during playback of an LD, a playback position slightly ahead of the last frame to be played is stored in memory (last memory). When the power is turned back on, playback begins from the memorized position by pressing ►/II on the front panel.

CD (Compact Disc)/CDV (Compact Disc with Video) Playback functions

Direct CD function

Pressing DIRECT CD on the front panel instructs the unit to use the CD disc table, which reduces the play starting time. In addition, since the picture circuit does not function, the player eliminates the interference between signals and reproduces more pure sound.

Other Features

1-Bit DLC D/A Converters

D/A converters are devices for transforming digital signals into analog signals. The D/A converter used in this player employs an advanced 1-bit conversion system. Compared to conventional converters, this system has the following advantages.

- Theoretically no zero cross distortion is generated.
- The system is free of non-linear distortion throughout the frequency range.
- High-precision operation can be obtained without adjustments.

With this type of conversion, there is no loss of music quality even at minute signal levels. Moreover, the originally developed D/A converter employs a high sampling frequency and a low-noise shaping function, which suppresses undesired noise outside of the band. Also, the low master clock rate of 18.83 MHz minimizes the effect of jitter, producing a stable signal.

Auto Loading and Automatic Disc Discrimination Functions

This unit has a built-in motor-driven auto loading mechanism which automatically opens and closes the disc table and makes disc loading easy.

Also, once a disc is placed on the table and the table is retracted into the player, the player automatically detects which type of disc (LD, CD, or CDV) is loaded.

Compatibility with Many Disc Types and Sizes

In addition to conventional LDs (12-inch, 8 inch), CDs (5-inch), and CDV discs (5-inch), the player can play thin-type 8-inch LDs and 3-inch CD singles without an adapter.

Film mode







When Film Mode is ON, the front panel display window and screen display are turned off during playback, and the screen goes black when changing disc sides. Play starting time and the time required to change disc sides is shorter than during normal playback. This mode is most suitable for playback of movie discs.



Digital Level Control Using SCAN control Adjustment.

TYPES OF DISCS THAT CAN BE PLAYED WITH THIS UNIT

This unit is a CD VIDEO SYSTEM (*1) compatible player which can play CDs, CDV discs, and LDs. The five disc types listed in the table below can be played with this unit.

- The marks shown in the left column are printed on the labels and jackets of the corresponding discs.

Mark	Disc	Size	Number of recorded sides	Audio recording system	Video recording system	Other
	CD (Compact Disc) Single	3-inch	One side	Digital (20 minutes max.)		TOC (*2)
	CD (Compact Disc)	5-inch	One side	Digital (74 minutes max.)		TOC
 CDV or  LASER DISC	CDV VIDEO SINGLE VIDEO SINGLE DISC 	5-inch	One side	Digital (5 minutes max.)	CLV (*3) (5 minutes max.)	TOC *
	CDV (CD with Video)	5-inch	One side	Digital (20 minutes max./ 5 minutes max.)	CLV (*3) (5 minutes max.)	TOC *
 LD CD VIDEO	CD VIDEO LD (*4)	12-inch, 8-inch	Two sides, one side	Digital/analog	CAV (*5) CLV	TOC **
 LASER DISC or  LaserVision	LD (LASERDISC/ LaserVision Disc)	12-inch, 8-inch	Two sides, one side	Digital/analog (*6) or analog only	CAV, CLV	

* There are some discs marked with the  mark instead of the  mark.

** There are some discs without the  mark.

LD GLOSSARY

Chapter number

Chapter numbers are used to indicate the boundaries of the sections on a disc, similar to the "chapters" in a book. If chapter numbers are recorded on a disc, it is so indicated on the jacket of the disc, etc. Chapter numbers can be used to search for desired chapters (Chapter Search).

Frame number

Frame numbers are the numbers assigned to each picture frame on a CAV (standard play) disc. Frame numbers can be used to search for desired frames (Frame Search).

Time number

Time numbers indicate the time elapsed from the beginning of a CLV (extended play) disc. Time numbers can be used to search for desired scenes (Time Search).

CDV/CD GLOSSARY

Track number

Track numbers indicate the boundaries of the sections, or "tracks", on a disc. Track numbers are assigned consistently throughout the audio part and video part of a CDV disc. Track numbers can be used to search for desired tracks (Track Search).

TOC (*2)

Every CD/CDV-type disc is provided with a section called TOC (Table Of Contents) at the beginning of the disc. The TOC section is just like the table of contents of a book, and contains information on the contents (number of tracks, playing time, etc.) of the disc.

- Some LD discs are also provided with a TOC section.

CD VIDEO SYSTEM (*1)

The CD VIDEO SYSTEM is the standard name for the "optical video disc with digital audio" system that encompasses both LDs and CDV discs.

The following mark is the standard mark for the CD VIDEO SYSTEM and is found on all players and discs which conform to the CD VIDEO SYSTEM format.

The following systems are included in the CD VIDEO SYSTEM:



- CDV (CD VIDEO CDV) discs
- LaserVision Discs (CD VIDEO LDs) containing digital audio with sub-codes
- Compatible players which can play CDs and CDV discs
- Compatible players which can play CDs, CDV discs, and LDs

CD VIDEO LDs (*4)

A CD VIDEO LD is an LD with digital audio which is encoded with sub-codes (data such as TOC and track number data, excluding audio and video signals).

LDs (LASERDISCS)

With this unit, only play LaserDiscs which bear the following mark.

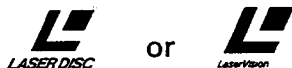

This mark is the standard mark for LaserDiscs.

Players and discs which bear the LaserVision mark are mutually compatible as long as they conform to the same television system.

Two types of standard LaserDisc are available — standard play (CAV) (*5) discs and extended play (CLV) (*3) discs — which differ with respect to their signal recording systems.

CAV (*5) DISCS

The jackets and labels of these discs are marked with a "Standard Play Disc CAV" or "Standard Play" indication.

Frames are recorded on these discs at a ratio of one frame per disc revolution, and the discs are played at a fixed rotational speed (CAV = Constant Angular Velocity) of 1,800 rpm. This system is well suited to special playback modes such as still frame playback and multi-speed playback. One side of a CAV disc can have a playback time of up to 30 minutes (for a 12-inch disc), which is equivalent to 54,000 frames. Each frame — from frame 1 to frame 54,000 — is encoded with its own frame number.

* Playback time varies according to the contents of the disc.

CLV (*3) DISCS

The jackets and labels of these discs are marked with a "Extended Play Disc CLV" or "Extended Play" indication.

Signals are recorded on these discs at a constant linear velocity (CLV), and the rotational speed during playback varies from 1,800 rpm for the innermost track to 600 rpm for the outermost track. As a result, one side of a CLV disc can have a playback time of up to 60 minutes (for a 12-inch disc), which is twice as long as a standard play (CAV) disc. CLV discs are encoded with time numbers which correspond to the elapsed play time from the beginning of the disc.

* Playback time varies according to the contents of the disc.

LASERVISION DISCS WITH DIGITAL AUDIO (*6)

The jackets and labels of these discs bear the following mark.

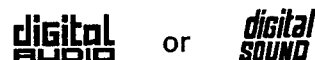

These are LaserDiscs which contain digital audio signals in addition to conventional analog audio signals. This feature allows the high image quality of LaserDiscs to be enjoyed together with the superior quality of digital sound. The digital and analog audio signals are recorded on the disc using different frequency bands.

LASERVISION MULTI AUDIO DISCS WITH DIGITAL AUDIO

The jackets and labels of these discs bear the following mark.



These are LaserDiscs in which the recorded digital and analog audio signals differ in content. This allows the user to enjoy two different audio soundtracks by switching between the digital and analog sound.

CDV (COMPACT DISC WITH VIDEO) DISCS

These are compact discs which also contain video signals. Of the total 25-minute playback time of a CDV disc, 20 minutes is encoded with conventional CD digital audio signals (the "audio part"). The remaining 5 minutes is encoded with both video and digital audio signals (the "video part").

CARE OF DISCS

How to hold discs

When loading or removing discs, try not to touch their playing surfaces.

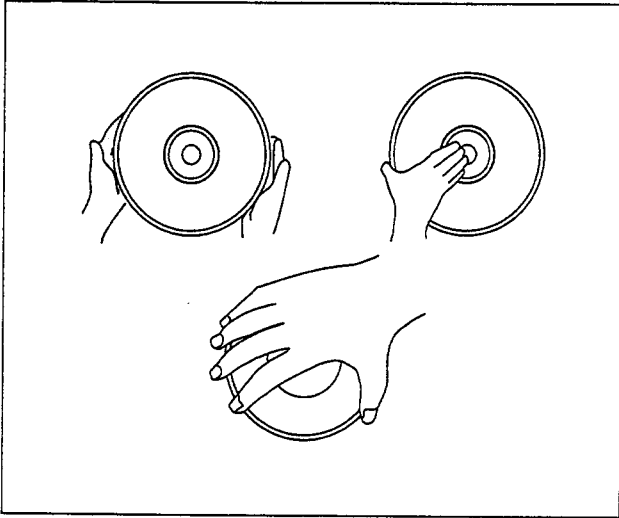

Cleaning

Fingerprints or other dirt on the disc may affect sound and picture quality.

To clean your discs, use a soft clean cloth to wipe them. If necessary, moisten a soft cloth with diluted neutral detergent to remove heavy dirt or fingerprints.

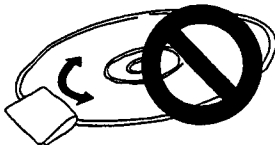

Do not wipe in a circular direction

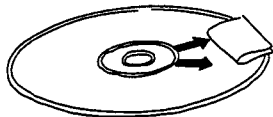

Gently wipe from the inside toward the outer edge.

Discs must not be cleaned with record cleaning sprays, or static prevention sprays, etc. Also do not use volatile liquids such as benzene, or thinner, etc.

NEVER PLAY CRACKED OR WARPED DISCS.

■ The disc revolves on the player at a high speed when it is played. Never play a cracked, scratched or warped disc. This may damage the player or cause it to malfunction.

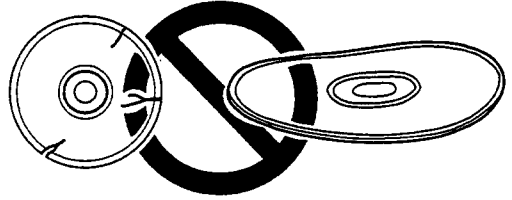

After using discs, store them upright

After playing a disc, always remove it from the player and return it to its jacket. Then store it standing upright away from heat and humidity.

- Store discs carefully. If you store discs at an angle, or stacked on top of each other, discs may become warped even when in their jackets.
- Do not leave discs in locations such as the seat of car, which may become excessively hot.

If an LD disc is warped...

If an LD disc is warped, put the disc into its protective envelope, and then place it between two flat boards. Then place heavy books on top of the plates so that approximately 4 to 5 kgs (10 lbs) is applied. Leave the disc like this for a day or so. This may correct the warp.

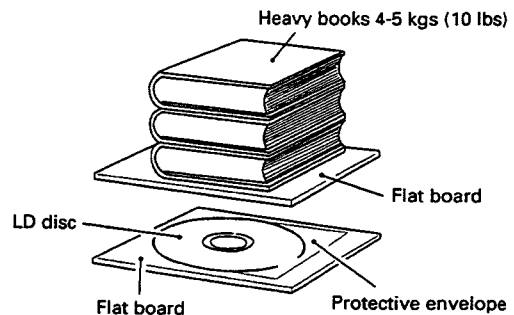

CAUTION WHEN USING THE DISC

All rights reserved.

Unauthorized public performance, broadcasting or copying is a violation of applicable laws.

CONNECTIONS

● Only televisions equipped with a video input can be connected to this unit.

USING TELEVISION WITH AUDIO AND VIDEO JACKS

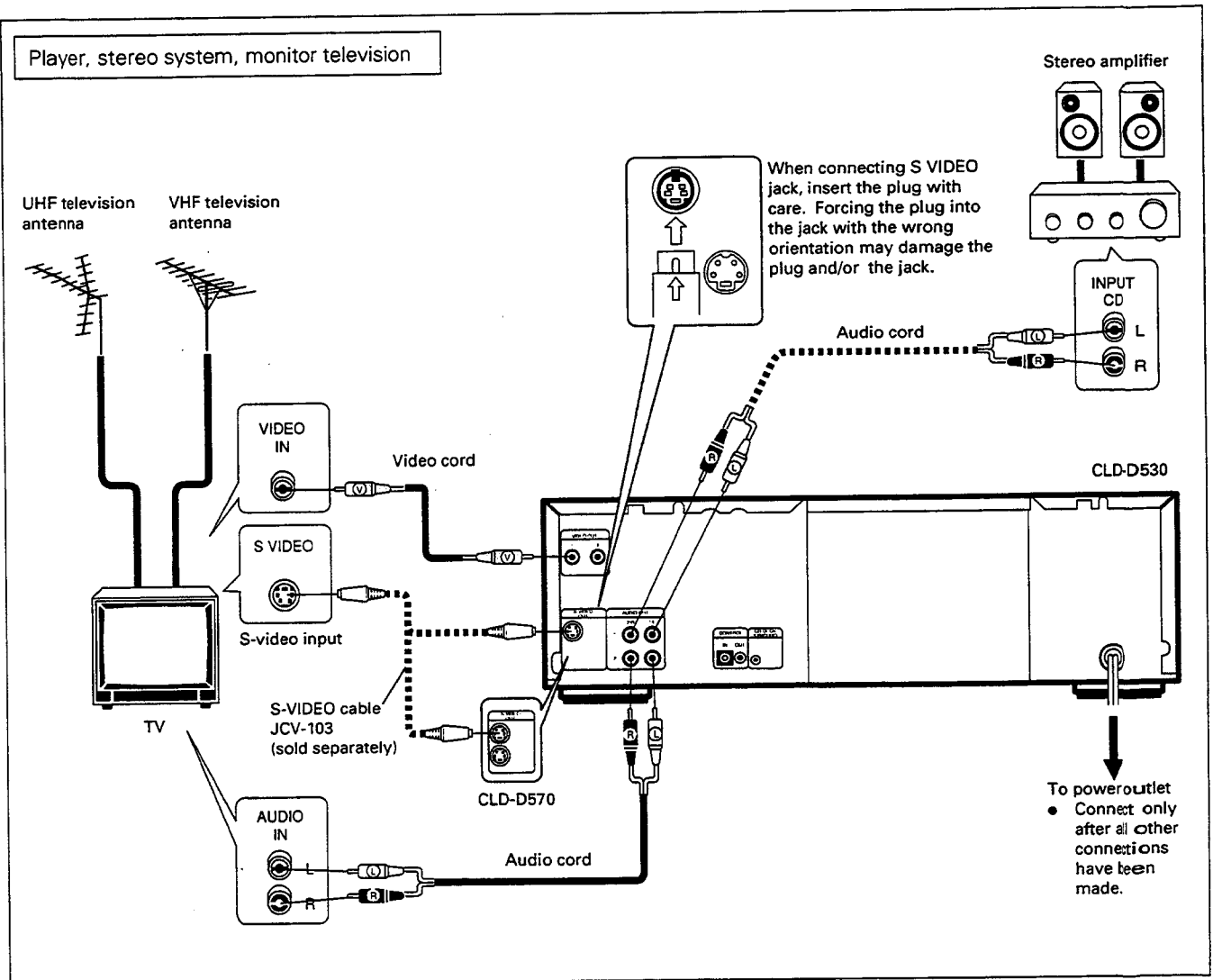

- Connect the VIDEO OUT jack of the player to the video input jack of the monitor television.
- When connecting to TV equipped with the S-Video input jack, the S-VIDEO connection is recommended to obtain superior picture quality.
- Connect the AUDIO OUT jacks to the stereo amplifier AUX, CD, LD, VDP or other jacks, except the PHONO input jacks. The television speakers can also be used by connecting the television audio input jacks and the player AUDIO OUT jacks. However connection to a stereo amplifier is recommended to obtain superior audio playback quality for Compact Discs and LaserDiscs. Do not change the television antenna and VCR connections.
- Connect the power cord to an AC wall outlet.
- Combined system control is possible when a Pioneer television and audio/video stereo receiver are connected. Refer to page 13 and 14 for an explanation of the connection procedure.

CD-DECK synchro function

If you have a Pioneer cassette deck provided with the CD-Deck synchro function, connect the CD-DECK SYNCHRO jacks of the player and cassette deck. With this function, synchro recording can be carried out between player and deck.

- With CD as well as CDV and LD, the CD-Deck synchro recording can be carried out.
- For details on connections and operation, refer to the operating instructions supplied with the cassette deck.

CONNECTIONS

Stereo amplifier connections

Connect the AUDIO OUT jacks of the player to the AUX, CD or LD input jacks of your stereo amplifier.

NOTE:

Do not connect these terminals to your amplifier PHONO input jacks.

Connecting to an optical digital jack (except for U.S. and Canadian models)

This unit can be connected to an amplifier equipped with an optical digital jack.

1. Remove the protective dust cap from this unit's OPTICAL DIGITAL OUT jack.
 2. Use an optical fiber cable to connect OPTICAL DIGITAL OUT jack of this unit to the optical digital input jack of the amplifier.
- Align the plug of the optical fiber cable with the optical digital jack and fully insert the plug to make a secure connection.

Use a separately sold optical fiber cable for the optical digital jack connections. However, when making optical digital connections, the player can only be connected to an amplifier which uses the same type of optical transmission/reception module.

Precautions concerning use of optical fiber cables

- Fully insert the optical fiber cable plugs all the way into the jacks.
- Be careful not to fold or crimp the cable. When coiling an optical fiber cable for storage, make sure the diameter of the coil is 15 cm (6 inch) or larger.
- Use an optical fiber cable with a length of 3 m (10 feet) or less.
- Protect the optical fiber cable plugs from scratches and dust.
- When the unit is not connected using an optical fiber cable, be sure to keep the protective dust cap plugged into the optical digital output jack at all time.

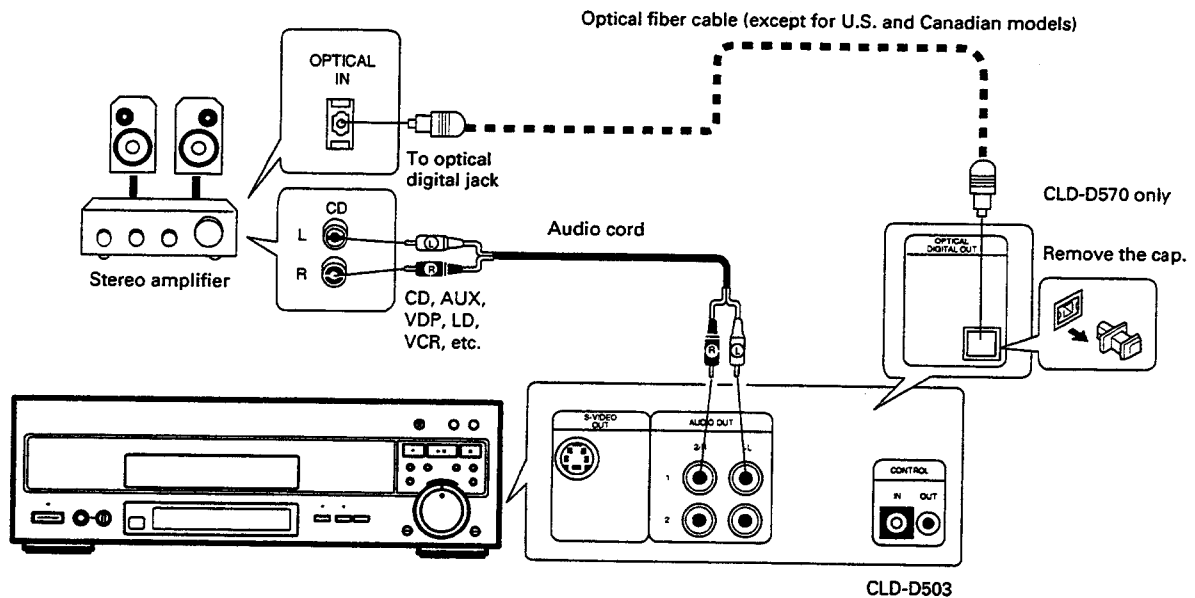

Plug the AC power cords of the player, stereo amplifier and TV set into an AC outlet.

When the power cord of this unit is connected to an AC outlet, power is supplied to the unit's internal memory (such as the last memory) even when the POWER switch is OFF. Therefore, be sure to connect the power cord directly to a wall outlet. If the power cord is connected to an outlet such as a switched outlet on an amplifier, the various memory contents will be erased whenever the amplifier's power switch is turned off.

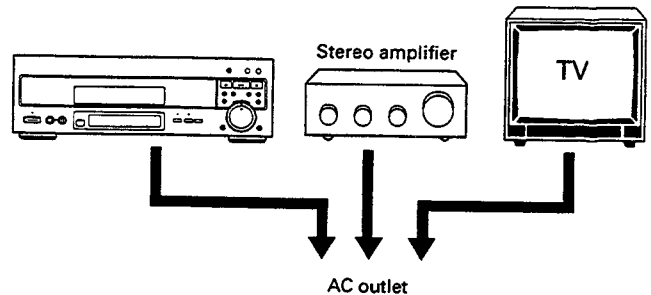

SYSTEM REMOTE CONTROL CONNECTION

WHEN COMBINED WITH OPTIONAL PIONEER PROJECTION MONITOR (or COMPONENT DISPLAY)

Connect the VIDEO OUT jack of the player to the video input jack of the projection monitor (or component display), and connect the AUDIO OUT jacks of the player to the audio input jacks of the projection monitor (or component display).

System Control

By connecting the CONTROL IN jack of the player to the remote jack of the projection monitor (or component display), the system can be controlled by the remote control unit of the player at the remote control sensor of the projection monitor (or component display).

- Use a commercially available cord with mini-plugs for the connection.

Please also refer to the operating instructions for the projection monitor (or component display).

NOTE:

When system control connections have been made, the player cannot be directly controlled by the remote control unit. To operate the player, aim the remote control unit at the projection monitor (or component display).

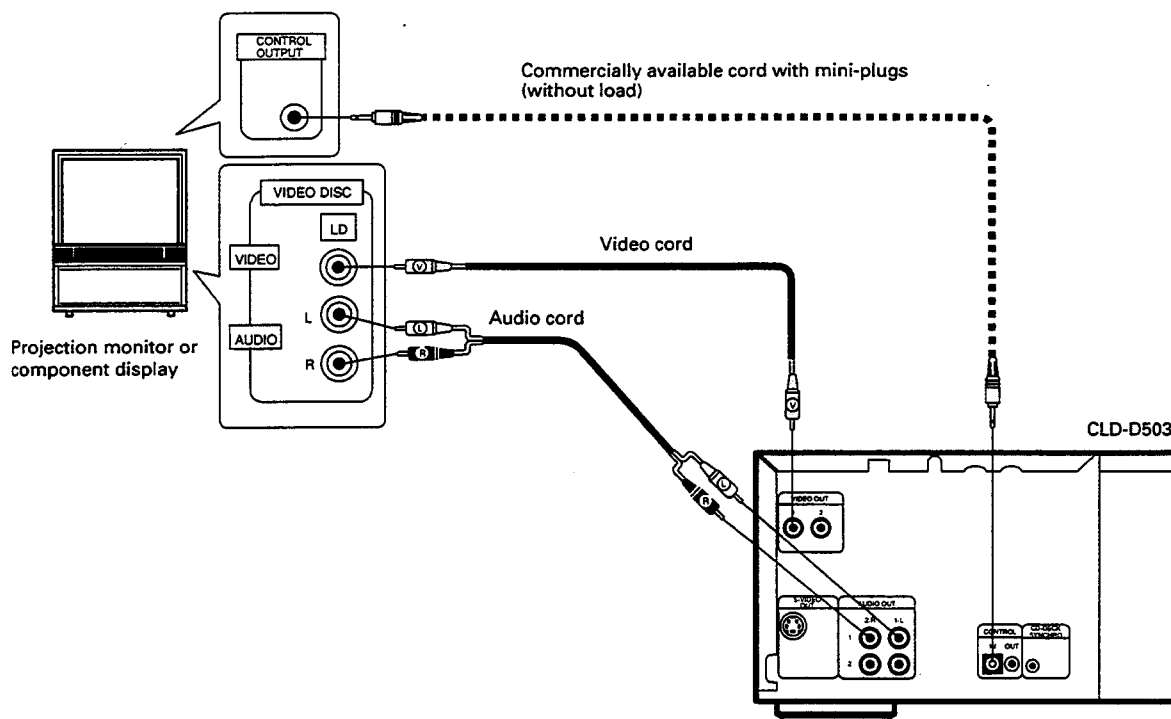

CONNECTIONS

PERFORMING SYSTEM CONTROL WHEN THE PLAYER IS COMBINED WITH A PRODUCT THAT HAS THE MARK

System control can be performed when the player is combined with an optional AV amplifier, which can provide centralized control of Pioneer products with the  mark. Connect the VIDEO OUT jack of the player to the video disc video input jack of the AV amplifier and connect the AUDIO OUT jacks of the player to the audio input jacks of the AV amplifier.

Connect the CONTROL OUT jack of the AV amplifier to the CONTROL IN jack of the player using a commercially available cord with mini-plugs.

- For details concerning the connection and operation methods, please refer to the operating instructions for the AV amplifier.

NOTE:

When a connecting cord has been connected to the CONTROL IN jack, direct control of the player with the remote control unit is not possible. Operate the player with the remote control unit by aiming it at the AV amplifier.

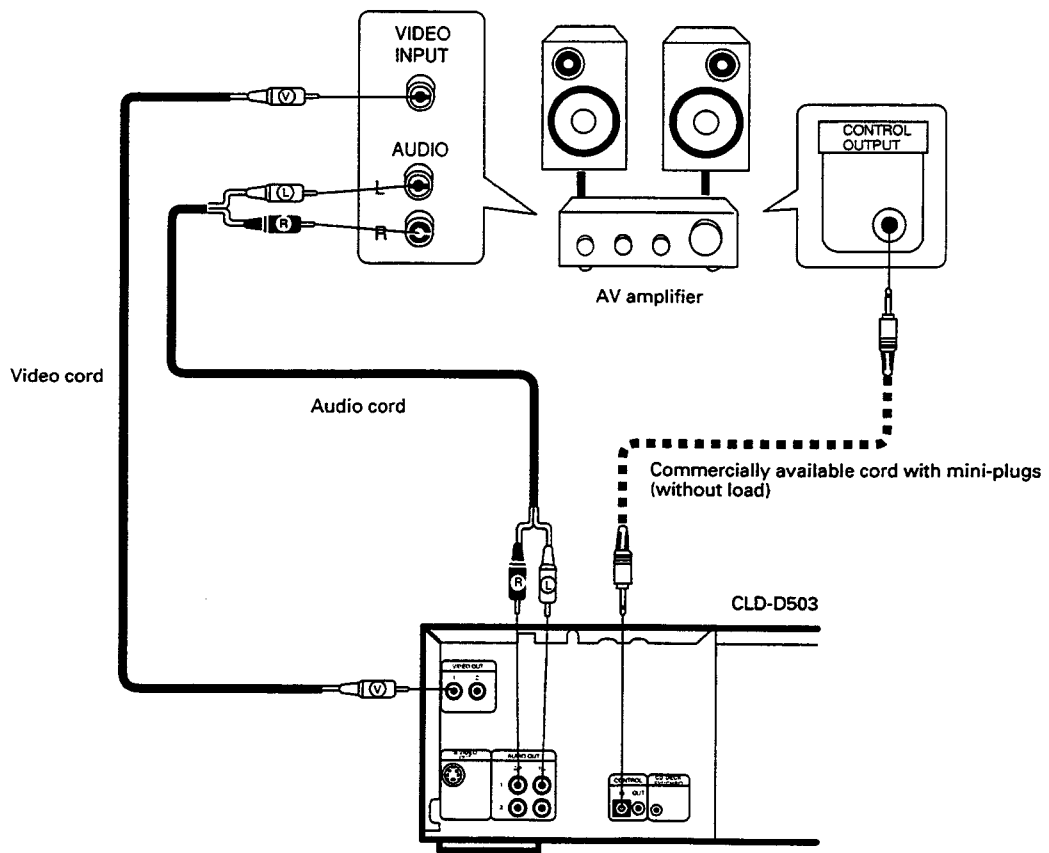

NAMES AND FUNCTIONS OF REMOTE CONTROL UNIT COMPONENTS

A detailed description is provided on the indicated page(s).

Remote control buttons with the same names or marks as buttons on the front panel of the player control the same operations as the corresponding front panel buttons.

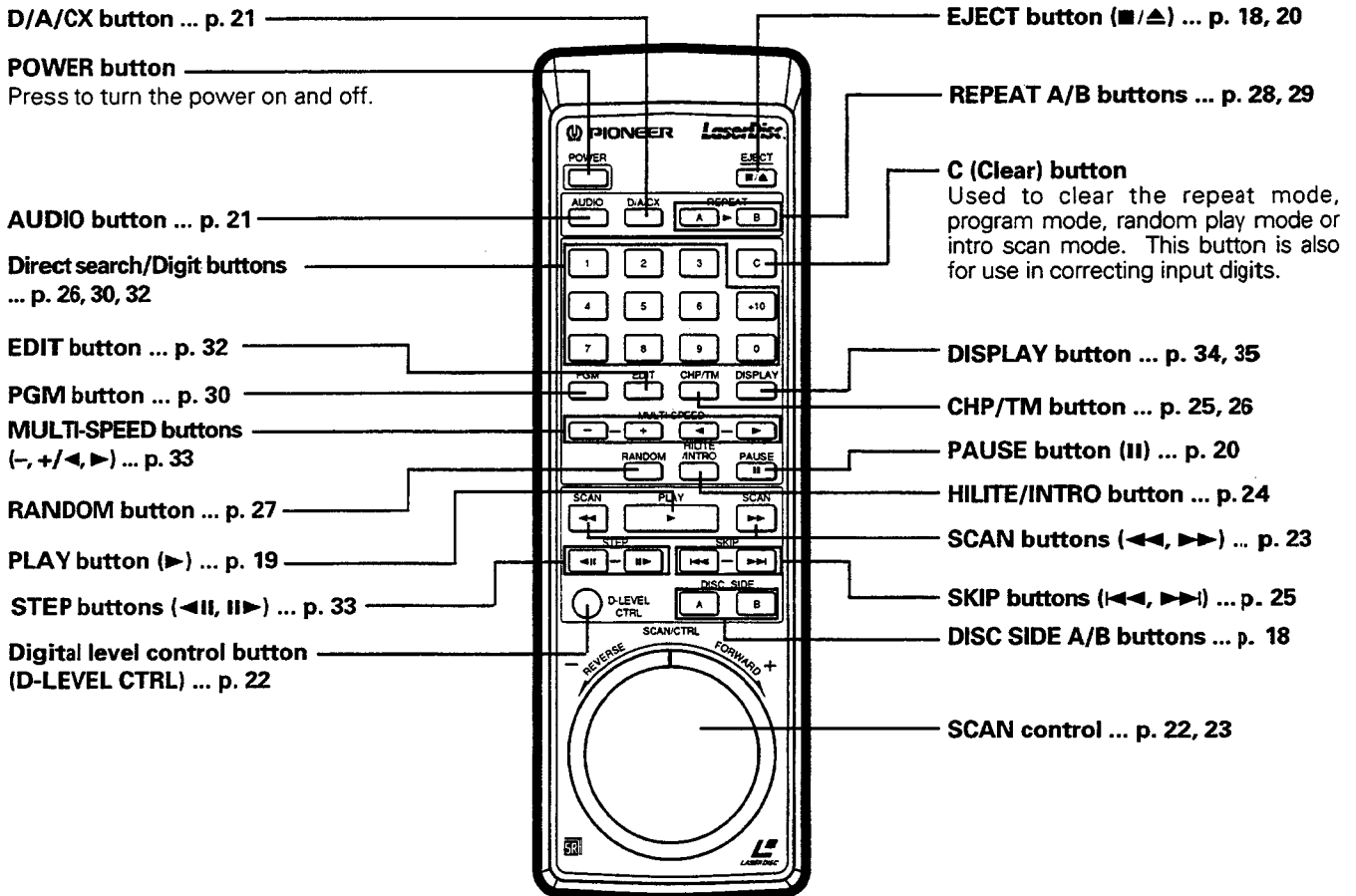

When operating the remote control unit, point the unit's infrared signal transmitter at the remote control receiver on the front panel of the player. The remote control unit can be used within a range of about 7 meters (23 feet) from the remote sensor, and within angles of up to about 30 degrees.

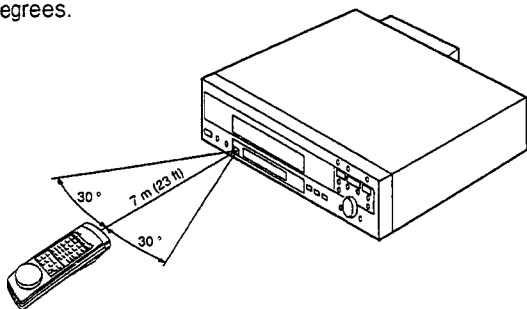

NOTES FOR USING THE REMOTE CONTROL UNIT

- If a plug is connected to the CONTROL IN terminal at the rear of the player, remote control operations cannot be done with the remote control unit aimed at the player's remote control sensor. Aim the remote control unit at the AV amplifier or the component display's sensor instead.

- If there is any obstacle between the remote control unit and the player, or if the unit is held at too large an angle relative to the front panel of the player, the signal from the remote control unit will fail to reach the remote sensor.
- If the player is operating in the vicinity of other appliances generating infrared rays, or if other remote control devices using infrared rays are used near the player, the player may operate improperly. Conversely, if the player's remote control unit is operated in the vicinity of other appliances which use an infrared remote control device, the other appliance may operate improperly. If this should happen, change the place of installation so that improper operation does not occur.
- If the range of operation of the remote control unit becomes too short, replace the batteries.
- When the unit is not to be used for a long period of time (more than one month), remove the batteries to prevent them from leaking inside the compartment. If leakage occurs, wipe up the liquid inside the compartment and replace the batteries with new ones.
- Do not place books or other objects on the remote control unit, since they might depress the buttons and run down the batteries.
- If the remote control sensor window is in a position where it receives strong light such as sunlight or fluorescent light, control may not be possible.

NAMES AND FUNCTIONS OF FRONT PANEL COMPONENTS

A detailed description is provided on the indicated page(s).

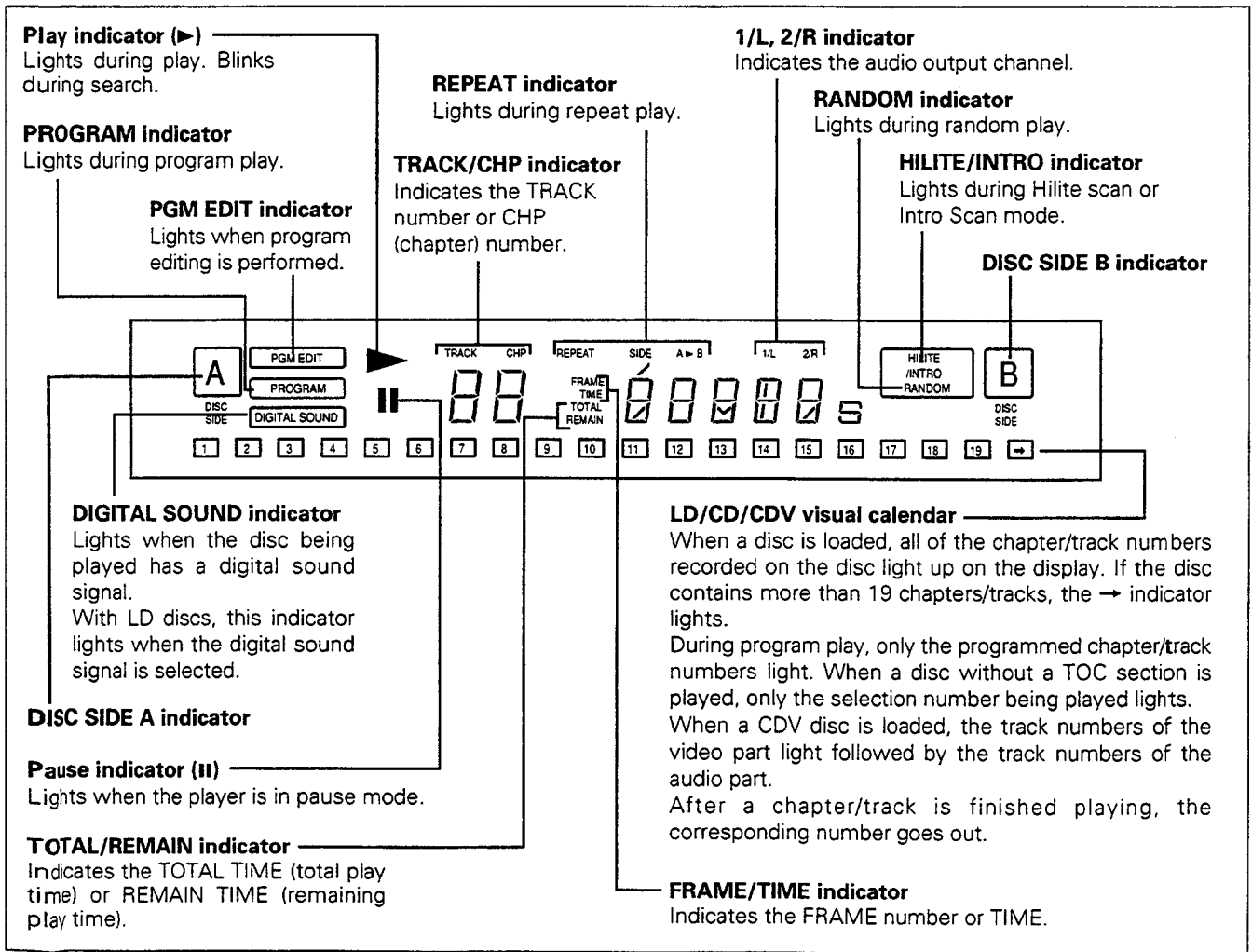
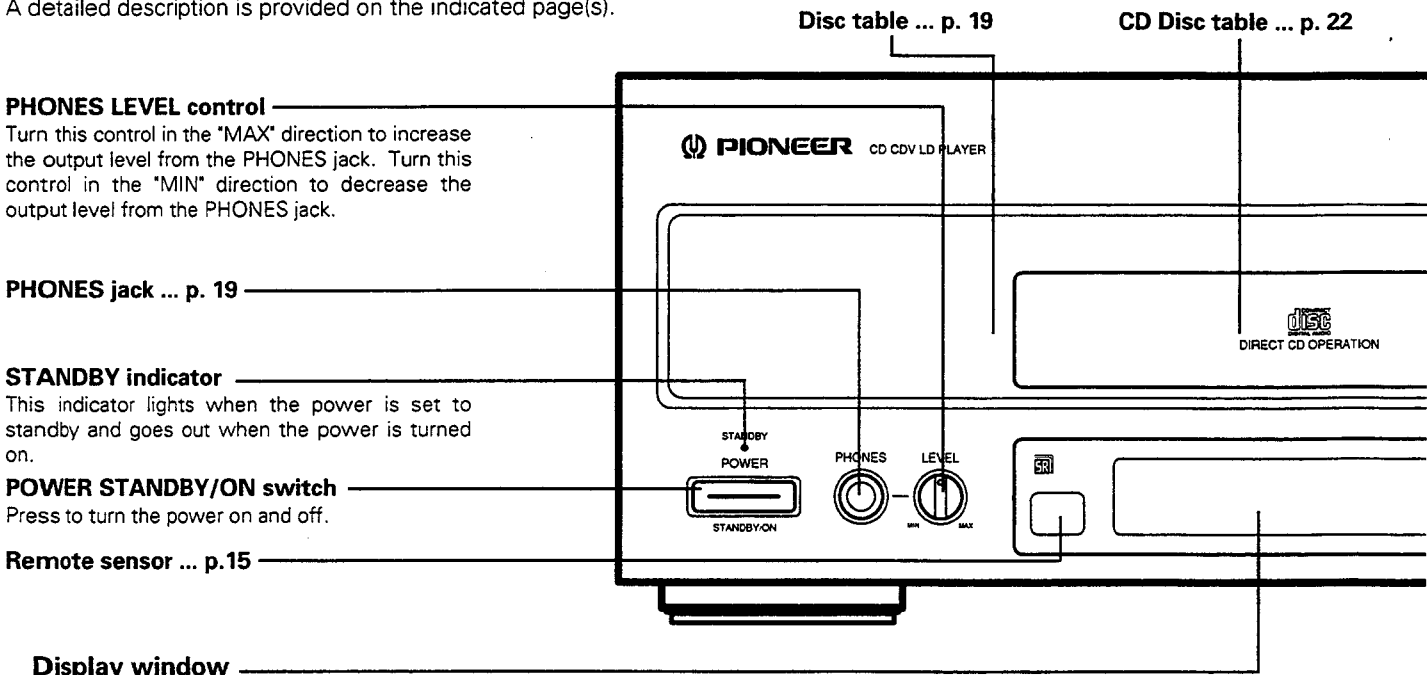

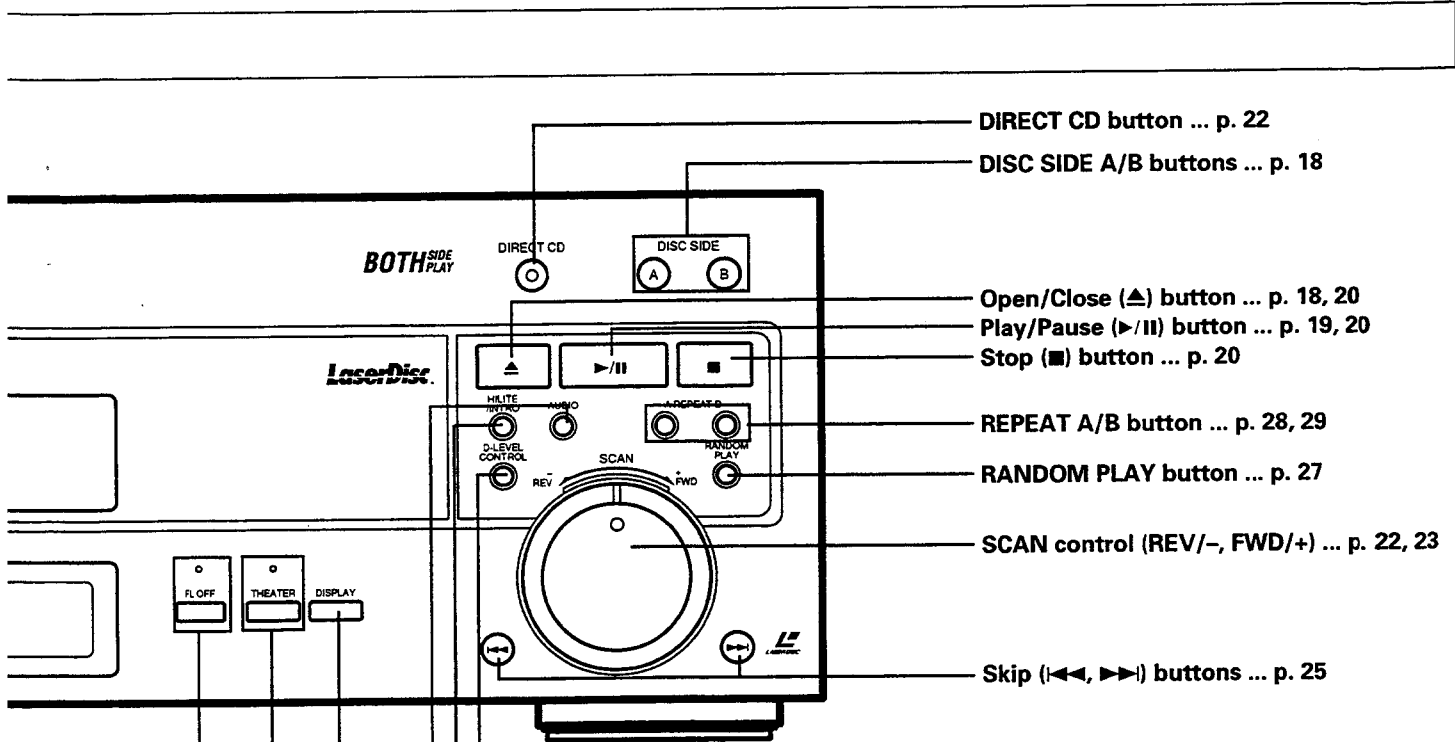

DIRECT CD button ... p. 22

DISC SIDE A/B buttons ... p. 18

Open/Close (▲) button ... p. 18, 20

Play/Pause (▶/||) button ... p. 19, 20

Stop (■) button ... p. 20

REPEAT A/B button ... p. 28, 29

RANDOM PLAY button ... p. 27

SCAN control (REV/–, FWD/+) ... p. 22, 23

Skip (◀◀, ▶▶) buttons ... p. 25

Digital level control button (D-LEVEL CTRL) ... p. 22

HILITE/INTRO button ... p. 24

AUDIO button ... p. 21

DISPLAY button ... p. 34, 35

FILM MODE button/indicator ... p. 23

Set to ON in accordance with your tastes, particularly when viewing movie discs.

FL OFF button/indicator

Pressing this button turns off the display in the front panel display window and causes the FL OFF indicator to light. Press the button again to cause the display to return. Turning off the display prevents low levels of noise from adversely affecting sound quality.

TO PLAY AN LD, CDV OR CD

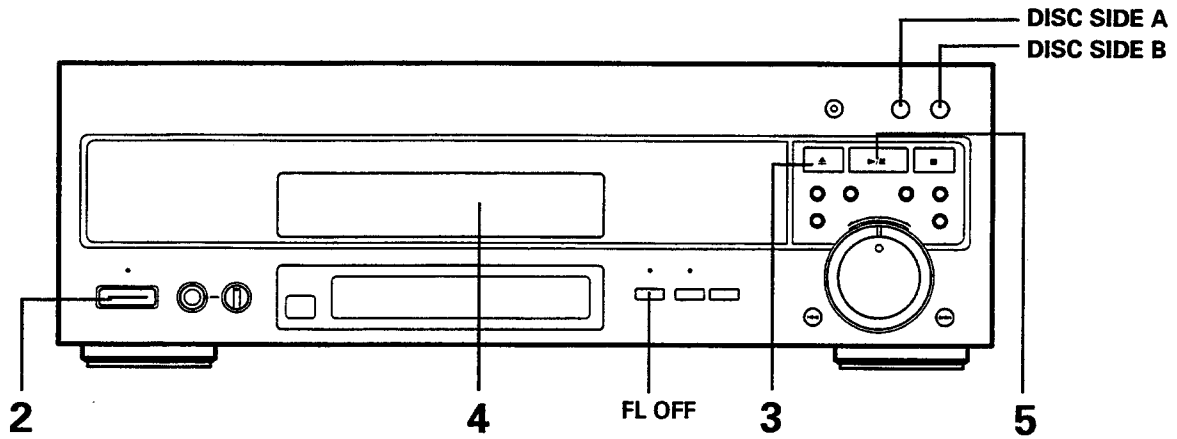

1
Turn on the power to the monitor TV and/or audio system.

When a stereo system is used for audio listening:
Turn on the power of the amplifier, and set its input selector to the proper position for listening to the player, such as "LD".

2
Turn on the power to this unit.

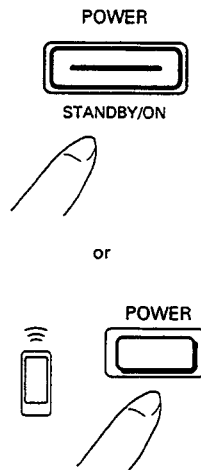

3
Open the disc table.

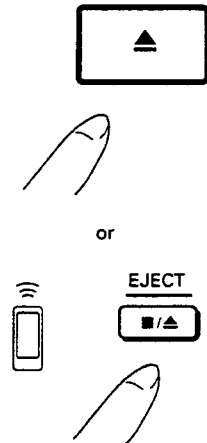

TIPS:
If ▲ on the front panel is pressed in the STANDBY mode, the power is automatically turned on and the disc table is opened.

State of the display window during playback:

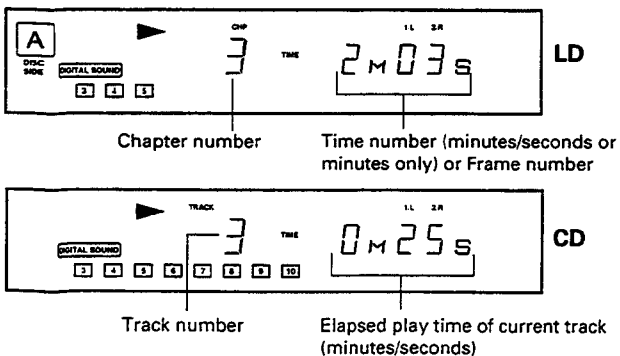

To specify and play a single side (side A or side B)

To play side A only, press DISC SIDE A instead of ►/■. Side A will be played and then playback will stop.
To play side B only, press DISC SIDE B instead of ►/■. Side B will be played and then playback will stop.

State of the display window during Gamma-turn:

- During switching from side A to side B
- During switching from side B to side A

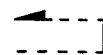
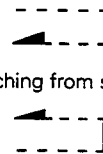

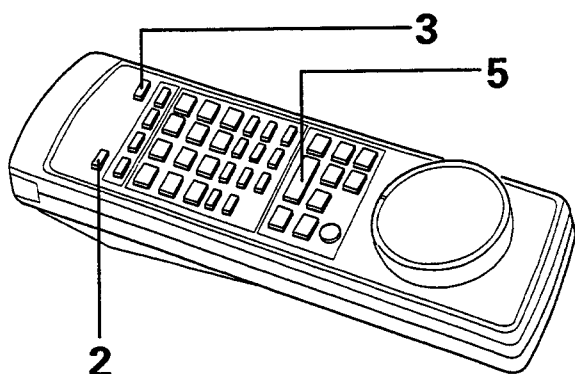

Front panel buttons and remote control unit buttons with the same name or mark have the same function.

Operations indicated by the [] mark are performed with the remote control unit.

4

Load a disc

As shown in the following diagram, place the disc on the disc table in the groove corresponding to the size of the disc. If the disc is not centered correctly on the disc table, the disc will not be played or the disc or the player may be damaged. Always place the disc correctly according to the required disc size on the disc table.

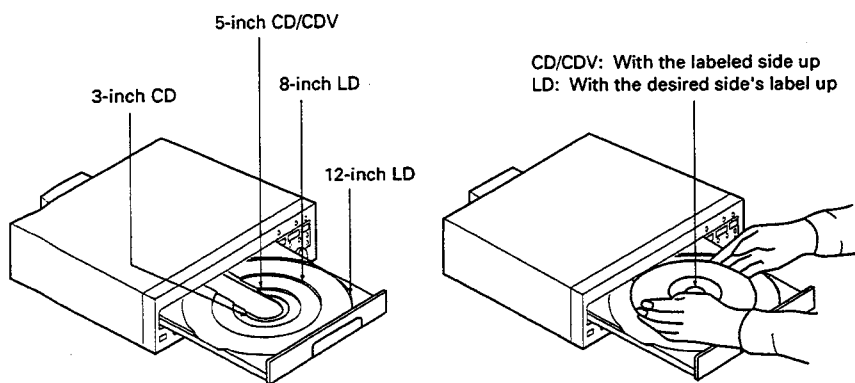

5

Start playback.

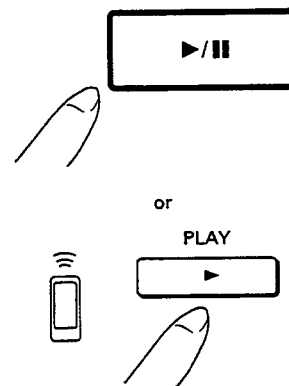

- With CDV discs, the video part is played first.
- With two-sided LDs, after the A side of the disc (the side facing upward) is played, the unit automatically begins playing the B side.

To avoid malfunctions, be especially careful about the following points.

- Do not place any object other than a disc on the disc table.
- Do not move the player while a disc is playing. This will cause the disc to be scratched.

Precautions concerning disc loading

- Do not place more than one disc on the disc table. If two discs are placed one on top of the other on the disc table, discs may be scratched and/or malfunction may occur.
- With this unit, playback of all types of discs is carried out without the use of adaptors. Therefore, do not use any type of adaptor with this unit.
- With CDs, CDV discs, and single-sided LDs, always be sure to load discs with the label side facing upward.

Last Memory function:

If the power is turned off during LD playback, a playback position slightly ahead of the current frame is stored in the unit's memory (Last Memory). When the power is turned back on and playback begins from the memorized position by pressing  on the front panel.

To play and listen to a disc without connecting this unit to an audio system:

Plug headphones into the PHONES jack on the front panel of this unit and adjust the volume with LEVEL control.

TO PLAY AN LD, CDV OR CD (Continued)

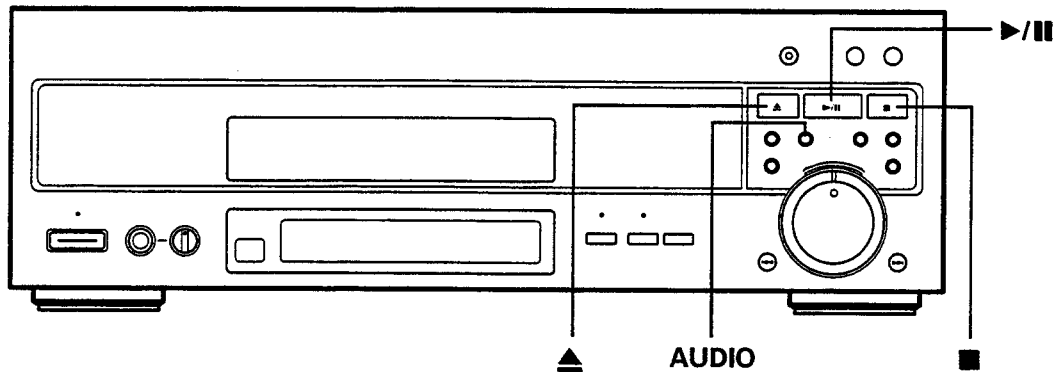

▶/||

To pause playback temporarily

The sound and/or video image disappears and the **||** indicator lights in the display window. Press **▶/||** or **PAUSE ||** again to resume playback from the position where pause mode was entered.

■

To stop playback



When **▶/||** or **PLAY ▶** is next pressed, disc playback starts again from the beginning.

▲

To stop playback and take out the disc

After removing the disc from the disc table, press **▲** or **PLAY ▶** to close the table.

Discs marked with the mark

Discs marked  are recorded with the CX noise reduction system for powerful audio reproduction with little noise. (Analog audio only) However, some discs marked are not encoded with the signals necessary to instruct the unit to automatically switch on the CX system. If sound is noisy or undulates when a disc with a  mark is played, press D/A/CX on the remote control unit.

-  is a trademark of CBS Inc. This player meets the CX EXPANDING SPECIFICATION.

To watch a TV broadcast:

Switch to the broadcast using the controls of your TV.

Automatic picture stop

Some of discs contain recording of a special code called the "picture stop code", which turns normal play or slow play automatically into still frame display.

To cancel the automatic picture stop operation, press and hold **▶/||** for more than 2 seconds until "PSC ON" (picture stop cancel ON) is displayed on the screen. To re-activate, press and hold **▶/||** for more than 2 seconds again until "PCS OFF" is displayed.

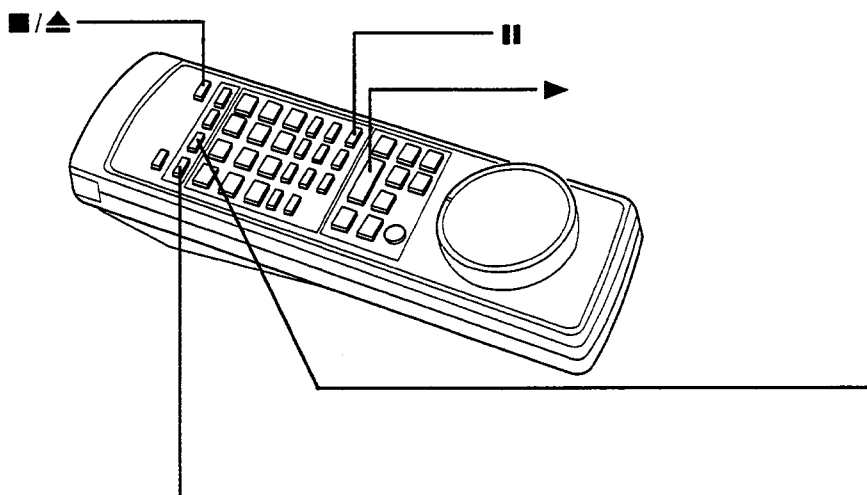

To listen to only one channel of a stereo disc, or to select the audio on a sound multiplex disc

During playback

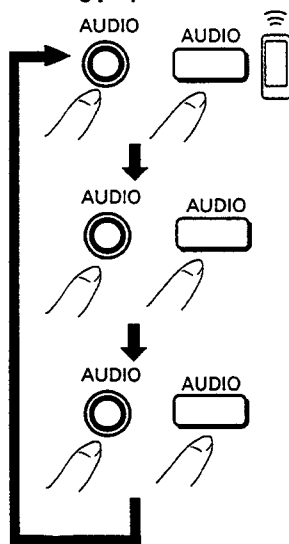

Played audio		Display on display window
Stereo disc	Sound multiplex disc	
Stereo	Audio 1/L (Left) Audio 2/R (Right)	1/L 2/R
Left	Audio 1/L (Left) <Karaoke>	1/L
Right	Audio 2/R (Right) <vocal>	2/R
Return to start		

To listen to the analog audio of an LD digital audio disc:

During playback

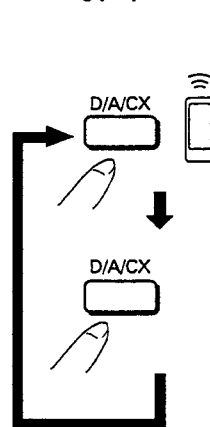

Played audio	DIGITAL SOUND indicator
Digital	Lights
Analog	Goes off
Return to start	

With a Multi Audio disc (an LD bearing the **digital** mark and the MULTI AUDIO mark or the **digital MULTI AUDIO** mark), you can listen to the various audio tracks recorded on the disc by using D/A/CX to select between the analog and digital audio tracks, and by using AUDIO to select between the left (1/L) and right (2/R) channels.

Examples of the various types of audio recorded on Multi Audio discs

Disc	Audio	Analog audio	Digital audio
Movies, animations, etc.		Audio of the main program	Soundtrack
Dual music		Music 1	Music 2
Various types of digital audio karaoke		1/L Karaoke (monaural) 2/R Assisting vocals	Stereo karaoke
Stereo bilingual		Native language	Foreign language 1

Disc	Audio	Analog audio	Digital audio
Trilingual		Native language	1/L Foreign language 1 2/R Foreign language 2
Quadrilingual		1/L Native language 2/R Foreign language 1	1/L Foreign language 2 2/R Foreign language 3

PARTICULAR FUNCTIONS FOR CD – Direct CD

Direct CD

Since the picture circuit is deactivated and the interference between signals is eliminated with the Direct CD function, more pure sound can be reproduced.

- When the Direct CD function is activated, the player does not display information on the monitor screen.
- In Direct CD mode, time for starting play becomes short compared with that of normal play operation.

1 Press DIRECT CD on the front panel.



2 Open the disc table.

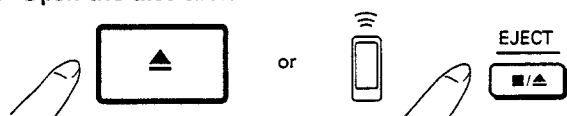

- The disc table comes out according to the CD size.

3 Load a CD on the disc table.

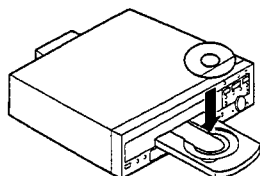

4 Start play.

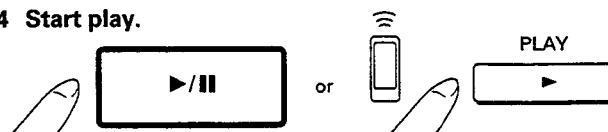

To exit Direct CD mode:

Press DIRECT CD again.

To play an LD:

Cancel the Direct CD mode. Otherwise, the LD cannot be set on the disc table.

NOTE:

During LD play, the player does not enter Direct CD mode even if DIRECT CD is pressed.

During CDV play, the player automatically turns on and off the picture circuit according to the video part or audio part in the Direct CD mode.

On screen display:

The information is displayed on the blue screen by pressing DISPLAY. Also, when programming or editing, the information is displayed.

By turning off the screen display or canceling the input mode, the player automatically turns off the picture circuit, and the screen turns to black.

LD/CDV/CD

TO ADJUST THE SOUND VOLUME – Digital Level Control

The SCAN control or the – button on the remote control unit can be used to lower sound volume by up to –25 dB. By rotating the control to the right or pressing the + button, the reduced sound volume can be returned to the 0 dB setting.

- The same kind of setting can be performed when using headphones.
- The modified sound level automatically returns to the 0 dB default setting when the power is turned off.
- Only digital recorded audio can be adjusted using this method; analog audio recorded on LDs cannot be adjusted in this way.
- When the digital audio level has been lowered using this control, pressing AUDIO to listen to analog audio will cause the sound level to rise suddenly. Be careful.

1. Press D-LEVEL CONTROL.

- The control level will be indicated on the screen.

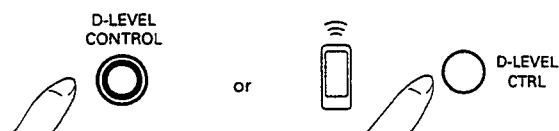

2. Rotate the SCAN control to the left or press the – button.

- The sound volume will be reduced.
- To return the sound level to its original setting, rotate the control to the right or press the + button.

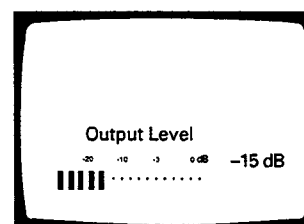
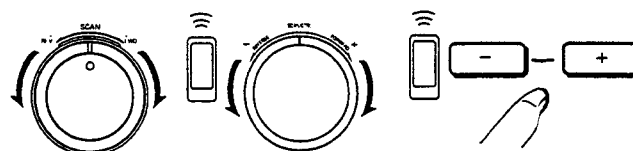

To cancel the digital audio volume function:

Press the D-LEVEL CONTROL button again.

WATCHING A MOVIE DISC – FILM MODE

Press **FILM MODE** on the front panel.

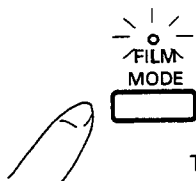

The FILM MODE indicator will light.

NOTE:

When the film mode is ON, the display in the front panel display window will not appear even when the power is turned on. In addition, the player memorizes the ON/OFF condition of the film mode even if the power is turned off, so the display will remain off the next time the power is turned on. To turn the display on again, press FL OFF.

Set to ON in accordance with your tastes, particularly when viewing movie discs.

When the film mode is ON:

- The display in the front panel display window turns off (can be turned on/off using the FL OFF button).
- The screen display (see pages 34 and 35) does not function.
- The screen is blacked (blacked) while changing disc sides.
- The TOC is not read, in order to shorten the side-changing time as much as possible. As a result, random playback, and edit playback cannot be performed, even when the discs contain TOC codes. In addition, the remaining time, ABS time and total time displays will not function. (These displays will function normally if the disc is played back once before using the film mode.)

LD/CDV/CD

TO SEARCH FOR A PARTICULAR PASSAGE – High Speed Scan

High speed scan – Search using fast forward or fast reverse

While rotating the SCAN control, playback advances or reverses at high speed. There are three scan modes which can be selected with rotational angles of the control.

- If the SCAN control is rotated in digital level control mode, the output level is changed. Press D-LEVEL CONTROL to cancel the digital level control mode, and then rotate the SCAN control.

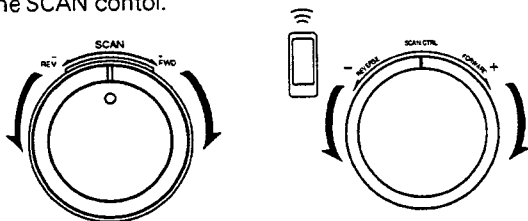

- In Clear Scan mode, when digital sound is selected with digital audio discs, sound is heard at low volume level.
- With CDs or audio part of CDVs, sound is heard at low volume level while scanning.
- Others: Sound is muted.

Clear Scan mode: Slightly rotate the SCAN control. The image may not fluctuate in this mode.

Low Scan mode: Further rotate the control. Scan speed becomes about x10 the normal playback speed.

High Scan mode: Fully rotate the control at greater angle. Scan speed becomes about x20 the normal playback speed.

- With CDs or audio part of CDVs, Clear Scan mode cannot be carried out.
- With video part of CDV, High Scan mode cannot be carried out.

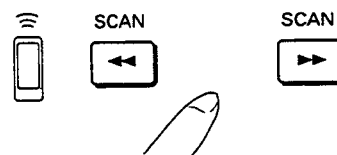

- If the SCAN button on the remote control unit is pressed without the image on the screen, Clear Scan is performed.
- If the SCAN button on the remote control unit is pressed with the image on the screen, high speed scan is performed. Scan speed becomes faster in 2 seconds except for the video part of CDV.

To switch the screen display, press the DISPLAY button.

Note on CAV:

While scanning, noise may occur on the screen. This is not a malfunction.

Notes on CLV:

- While scanning, the color of the image may fade out or the image sometimes fluctuates.
- The scan speed is different between inner tracks and outer tracks.

TO SEARCH FOR A PARTICULAR CHAPTER/TRACK

Hi-Lite Scan/Intro Scan

Hi-Lite Scan/Intro Scan

Hi-Lite scan (CD or audio part of CDV)

When HILITE/INTRO is pressed in the stop mode, playback starts from a point 1 minute after the beginning of the track, and each track is played for about 8 seconds. The HILITE/INTRO indicator is lit on the display in the Hi-Lite Scan mode. (On the screen, "Hilite" is displayed.)

Hi-Lite Scan can be carried out from the desired elapsed time of the track. During playback, press HILITE/INTRO at the point you want to start Hi-Lite Scan playback. The player memorizes the minute and second of the point and Hi-Lite Scan playback is carried out from the memorized minute and second on each track.

During the desired chapter or track is played, press ►/II or PLAY (►). The unit enters play mode.

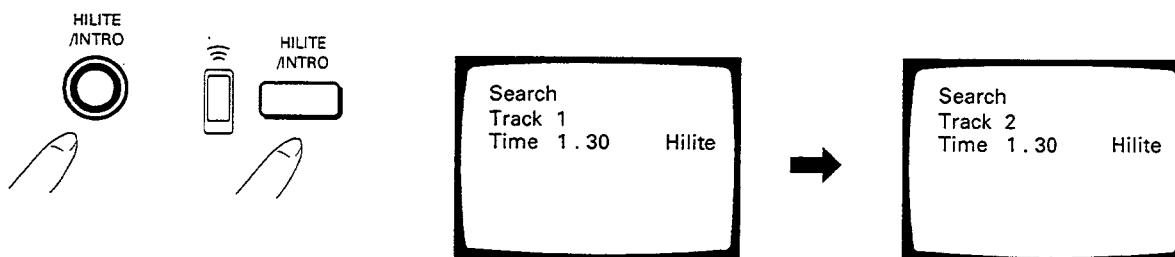

Intro Scan (LD or video part of CDV)

When HILITE/INTRO is pressed, the beginning of each chapter is played for about 8 seconds. The HILITE/INTRO indicator is lit in the Intro Scan mode.

During the desired chapter or track is played, press ►/II or PLAY (►). The unit enters play mode.

- With CDV, Intro Scan starts with the video part, and then the audio part will be played with Hi-Lite Scan.

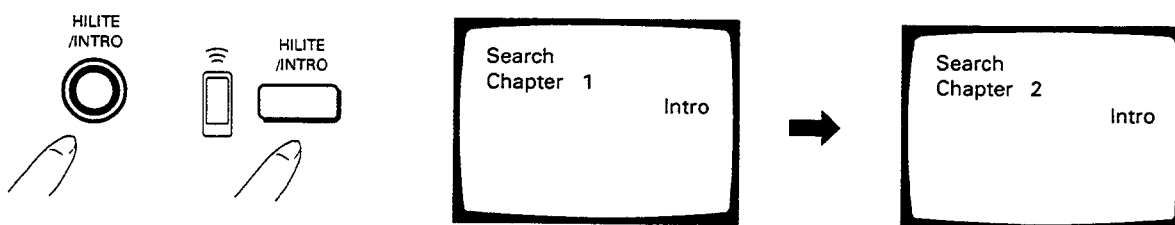

NOTE:

With discs which do not contain the chapter number, Intro scan cannot be operated.

TO SEARCH FOR A PARTICULAR CHAPTER/TRACK

Chapter (Track) Search/Chapter (Track) Skip

The term "chapter" refers to each section on an LD, and the term "track" refers to each section on a CD or CDV disc.

If chapter or track numbers are encoded on a disc, it is so indicated on the disc jacket.

- Chapter Search is not possible with discs which are not divided into chapters.

Chapter (Track) Search – To search by designating the chapter/track number

Example:

To play from the beginning of Chapter/Track 3:

<Direct Search>

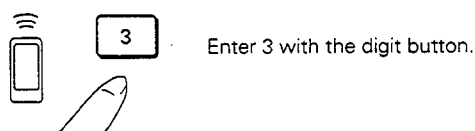

<Normal Search>

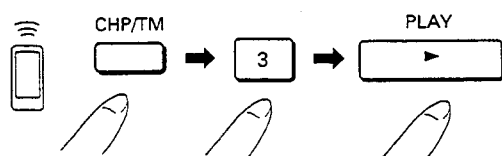

When the display shows Frame No. or Time No. press this button again.

Enter 3 with the digit button.

To search for chapter or track number 10 or above:

Use [+10] button.

(Example) To enter 17: [+10], [7]

To enter 30: [+10], [+10], [+10], [0]

If you make a mistake in pressing the digit buttons during normal search operation:

Press C (clear), and then press the correct button.

To identify the present chapter number and frame (or time) number:

The numbers are displayed in the front panel display window.

The information can also be displayed on the monitor TV screen by pressing DISPLAY.

CAV discs (for Normal Search):

When Chapter Search is started by pressing PLAY ► on the remote control unit, the beginning of the designated chapter is played with still frame.

Chapter (Track) Skip – To search for the beginning of a chapter/track

During playback:

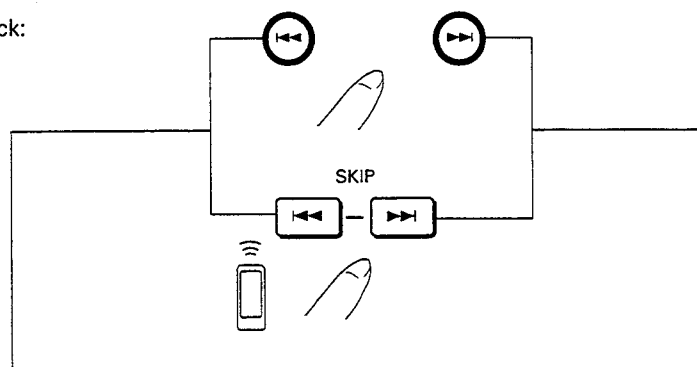

Press once to return the playback position to the beginning of the chapter/track being played. If the button is pressed more than once before the picture reappears, the beginning of a chapter/track located before the chapter/track being played is searched for and played. The position of the located track corresponds to the number of times the button is pressed.

If this button is pressed once or a number of times, playback is advanced to the beginning of a chapter/track located after the chapter/track being played. The position of the located track corresponds to the number of times the button is pressed.

To cancel the search function:

Press C (clear) during the search operation.

TO SEARCH FOR A PARTICULAR TIME/FRAME

Time Number Search/Track time Search/ABS Time Search/Frame Number Search

Time Number Search – Example: To search for the scene located at time number 12 min. 34 sec (CLV)

1. **Press CHP/TM during playback.**
When the display shows chapter No., press this button again.
2. **Enter [1], [2], [3] and [4] with the digit buttons.**
If you make a mistake during entry:
Press C (clear) to reset the time number to "0.00", and then press the correct digit buttons.
3. **Press PLAY ► or ►/II.**

CAUTION

If a disc does not contain information on the digits of seconds, specify the time number only as far as the minute digits.

Track Time Search – To search for a time on a specified track (CD/CDV)

1. **Press CHP/TM.**
2. **Press SKIP ◀◀ or ▶▶** so that the desired track number appears in the front panel display window.
3. **Enter the track time (elapsed time from the beginning of the specified track) with the digit buttons (0 - 9).**
4. **Press PLAY ► or ►/II.**

ABS Time Search (CD only) – To search for a point by designating the elapsed time from the beginning of the disc

1. **Press CHP/TM so that "Ab" appears in the front panel display window. (On the monitor screen, "ABS" appears.)**
2. **Enter the elapsed time from the beginning of the disc with the digit buttons (0-9).**
3. **Press PLAY ► or ►/II.**
Playback starts from the specified elapsed time.

Frame Number Search (CAV discs only) – To search by designating the frame number

Any desired frame can be searched for by specifying its frame number.

1. **Press CHP/TM during playback. When the display shows chapter No., press this button again. "Frame 0" is displayed.**
2. **Enter the required frame number with the digit buttons (0 - 9).**
3. **Press PLAY ► or ►/II.**
The designated frame is played as a still frame.

NOTES:

- The +10 button does not function.
- If you make a mistake during entry, press C (clear) and press the correct digit buttons.

To exit search mode:

Press C (clear).

TO PLAY ALL CHAPTERS/TRACKS IN A RANDOM ORDER

- Random Playback

Random Playback allows all chapters/tracks of one side of a disc in random order.
Press RANDOM PLAY or RANDOM.

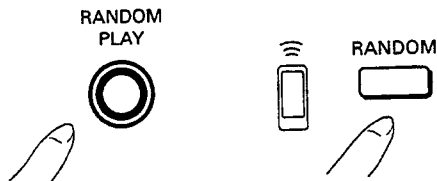

Display during Random Play (CD)

To display the music calendar, press DISPLAY so that the display shows time display.

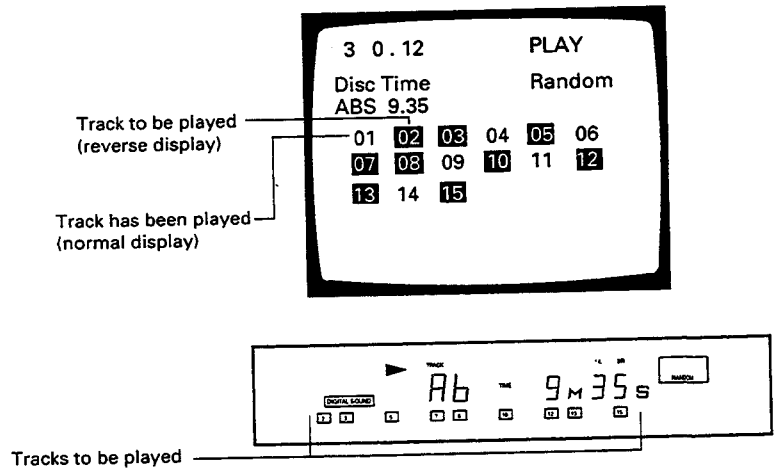

NOTE:

With Random Playback, chapter No. 0 will not be played.

To go to the next chapter/track during Random Playback:

Press SKIP ►►.
(The previous chapter/track cannot be played by pressing SKIP ◀◀.)

To stop Random Playback:

Press C (clear) on the remote control unit.
After C (clear) is pressed, playback will continue in the order in which the chapters/tracks are recorded on the disc.

To enter stop mode:

Press ■ or EJECT ■/▲.

Program Random Playback:

To play the programmed chapters/tracks in random order, press RANDOM PLAY during programming or program playback.

TO REPEATEDLY PLAY A DESIRED PASSAGE – Repeat Playback

- The REPEAT A/B buttons on the front panel are also used to carry out the following repeat playback functions.

Memory Repeat – To specify a point to return to later

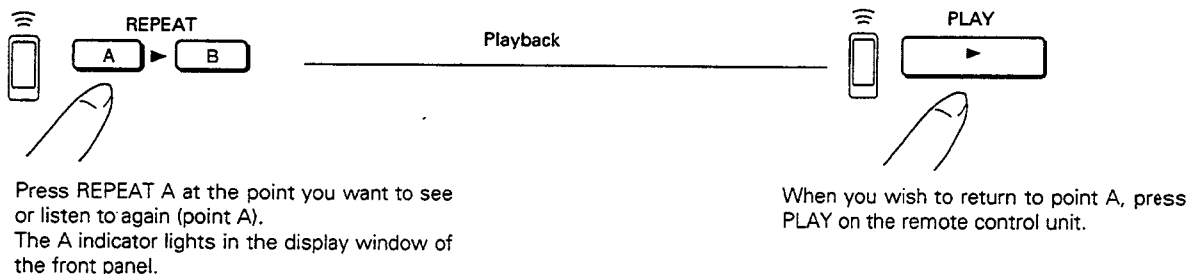

A-B Repeat – To repeat a specified section

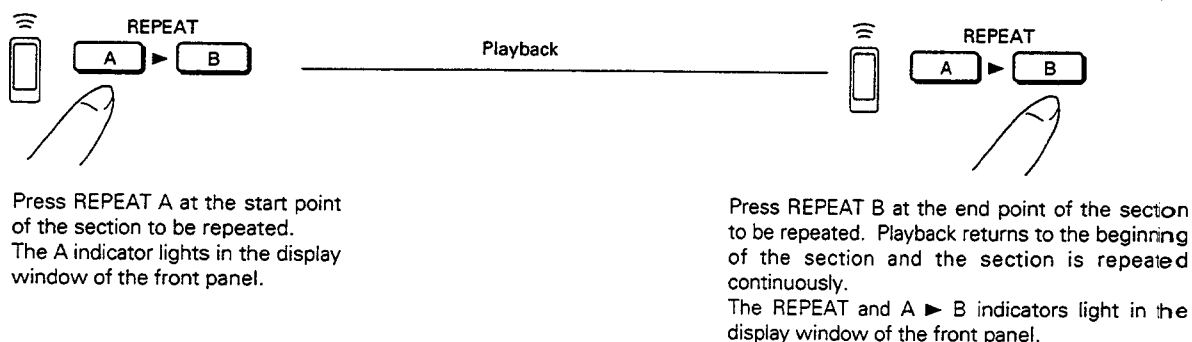

Chapter/Track Repeat – To repeat the current chapter or track

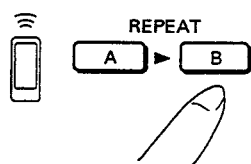

Press REPEAT B while the chapter/track to be repeated is playing. The REPEAT indicator lights in the display window of the front panel.

When the end of the chapter/track is reached, the player returns to the beginning of the chapter/track and the chapter/track is played back repeatedly.

To exit repeat mode:

Press C (clear) on the remote control unit. Repeat mode is canceled and normal playback continues from the current point.

To specify a different point in Memory Repeat mode:

Press REPEAT A at the new point. The previously memorized point is erased and replaced with the new point.

Memory Repeat and A-B Repeat with CDV discs:

These repeat functions can only be carried out within the video part or within the audio part, and cannot be carried out between the two parts.

For LDs which have no chapter numbers:

Chapter repeat cannot be carried out with these LDs. When REPEAT B is pressed once, one-side repeat will be carried out and when REPEAT B is pressed twice, two-side repeat will be carried out.

NOTE:

With two sided LDs, A-B Repeat from side A to side B cannot be carried out.

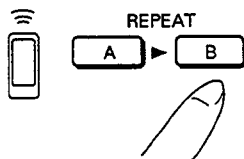
One Side Repeat – To repeat an entire side of a disc

Press REPEAT B twice while the side to be repeated is played back.
The REPEAT SIDE A or B indicator lights in the display window of the front panel.

When playback reaches the end of the playback side, the player returns to the beginning of the disc and the same side is played back repeatedly.

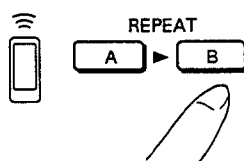
Two-Side Repeat – To repeat both side of a disc (for two-sided LDs only)

Press REPEAT B three times during normal playback.
The REPEAT SIDE A ► B indicator lights in the display window of the front panel.
Sides A and B are played back repeatedly.

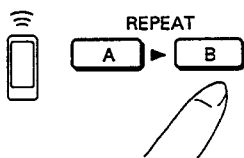
Program Repeat – To repeat a program

Press REPEAT B while the program is being played.

With the program repeat function, you can repeatedly play programmed chapters or tracks in their programmed order.

- See page 30 for details on programming.

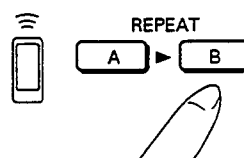
Random Repeat – To repeat a random play (for CDs, CDV discs and LD with TOC)

Press REPEAT B during random playback.

With the random repeat function, you can repeatedly play the chapters or tracks in random order.

- See page 27 for details on random playback.

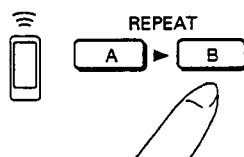
Program Random Repeat – To repeat programmed chapters or tracks in random order

Press REPEAT B during program random playback.

With the program random repeat function, you can repeatedly play programmed chapters or tracks in random order.

- See page 27 for details on program random playback.

TO PLAY ONLY DESIRED SCENES/TRACKS – Program Playback

Selected chapters (LD) or tracks (CDV/CD) can be played in any desired order (max. 24 chapters or tracks).

1 Press PGM.

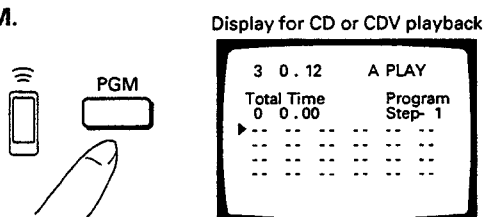

- You can view the state of programming on the monitor TV screen.
- With CDs or CDV discs, the total time of the programmed tracks can be displayed.

2 Select the desired chapters or tracks.

With two-sided LDs, first specify side A or side B with DISC SIDE A or B and then enter the number of the desired chapter with the digit buttons.

Example: To program chapter 9 on side B, chapter 7 on side A, and chapter 18 on side B, in that order:



Screen display after programming is completed

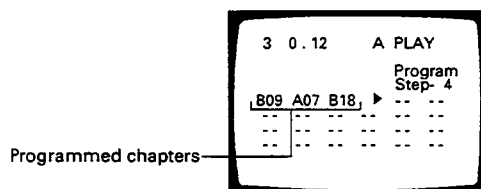

With single-sided LDs, CDs, and CDV discs, just enter the number of the desired chapter or track with the digit buttons.

Example: To program CD tracks 9, 7, and 18 in that order:

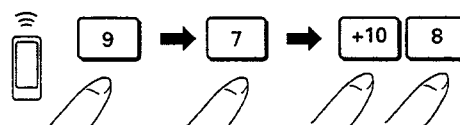

Screen display after programming is completed

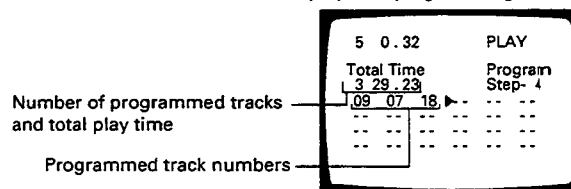

If you make a mistake during entry:

Press C (clear) and enter the correct number with the digit buttons.

3 Press PLAY ▶.

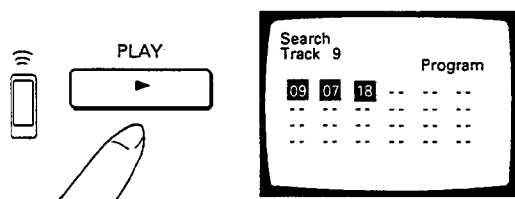

The chapters/tracks are played in the programmed order. When all programmed chapters/tracks have been played, the player enters stop mode.

To stop program play in the middle:

- Press ■ on the front panel of the player or EJECT ■/▲ on the remote control unit.
- Press C (clear) on the remote control unit.

To clear the program contents:

- Open the disc table.
- Press C (clear) on the remote control unit in stop mode.

Programming a pause:

Inserting a pause in your program can be very useful when carrying out recording.

- For example, when recording on both sides of a cassette tape, if you program a pause after the last track to be recorded in the first side, program playback will pause at that point to allow you to switch tape sides.
- Inserting pauses in a program will also allow you to record blank sections on a tape which are useful for music search functions, or to record narration between selections, etc.
- To resume program playback when the unit is in pause mode, press PAUSE II.

To program a pause:

In step 2 of the above procedure, press PAUSE II instead of entering a chapter or track number.

NOTES:

- A pause cannot be programmed for step 1, nor for two consecutive steps.
- A pause can be programmed for the last program step, however, it will not be effective.

Programmed pause indication:

On the monitor screen – II
In the front panel display window – PA

To check the program contents

During program playback or in stop mode, press PGM to display the program contents on the monitor screen. When PGM is pressed again, the program contents disappear.

To modify the program contents

To erase a programmed chapter/track or pause

- 1 Press PGM.
- 2 Press SKIP ◀◀ or ▶▶ to place the cursor (▶) on the left side of the chapter/track or pause to be erased.
- 3 Press C (clear).
- 4 Press PGM to complete programming. Pressing PLAY ▶ also completes programming and starts program playback with the new program contents.

To change a programmed chapter/track or pause to a new one

- 1 Press PGM.
 - 2 Press SKIP ◀◀ or ▶▶ to place the cursor (▶) on the left side of the chapter/track or pause to be changed.
 - 3 Enter the new chapter/track number with the digit buttons.
Press PAUSE || to enter a pause.
 - 4 Press PGM to complete programming. Pressing PLAY ▶ also completes programming and starts program playback with the new program contents.
- A programmed chapter/track being played cannot be erased or changed.
 - A programmed pause already engaged cannot be erased or changed.

To go to the previous or next chapter (track) in a program:
Press SKIP ◀◀ or ▶▶ on the remote control unit.

Total time display (CD and CDV only):

When programming for CD or CDV, the total time of the programmed tracks is displayed. If the total time exceeds 100 minutes, 100's digit will not be displayed in the display window of the front panel.

- If track No. 33 or more is programmed, the total time will not be displayed.

To view the program contents in the front panel display window:

Programmed chapter/track numbers light up on the visual calendar.

CAUTION

- If the SCAN control is rotated clockwise during Program Playback, the playback position will move to another chapter/track, but when the SCAN control is released, the next chapter/track in the program will be played. If the SCAN control is rotated counterclockwise, the played position returns to the beginning of the current chapter/track being played, but it will not go beyond it to a previous chapter/track in the program.
- If ▶ MULTI-SPEED is pressed during program playback, the unit will enter multi-speed playback mode and the playback position will move to successive chapters according to the order of the program.
If ◀ MULTI-SPEED is pressed during program playback, multi-speed playback will begin in the reverse direction but program playback will not be carried out.
- Do not program chapter/track numbers which do not exist on the disc, as this may inhibit execution of the program.

PROGRAMMING CHAPTERS/TRACKS TO BE PLAYED BACK WITHIN A SPECIFIED TIME PERIOD – Compu Program/Auto Program Edit

If the total playing time of both sides of the tape is specified, chapters/tracks are automatically programmed for both sides of the tape.

Compu Program Edit

The player selects the chapters/tracks so that their total playing time becomes the specified playing time as near as possible.

Auto Program Edit

Chapters/tracks are selected within the designated time, starting from the first track.

Compu Program Edit

1 Press EDIT once.

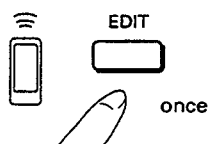

Auto Program Edit

1 Press EDIT twice.

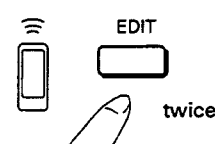

- With LD discs, after playback is performed, press EDIT.
- When EDIT is pressed during playback, the player enters pause mode.

2 Set the total playing time of both sides of the tape in minutes with the digit buttons (0-9).

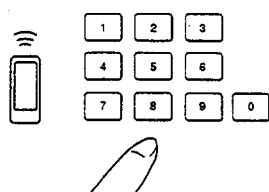

Press two digit buttons rapidly. For example, to enter 46 minutes, press the **4** button and **6** button sequentially.

3 Press PLAY ►.

Program playback starts.

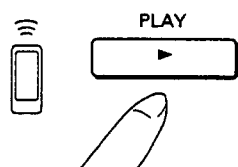

When playback of the first program is completed, the player enters pause mode. To play another program, press PLAY ►.

When all programs have been played, the player enters stop mode.

To clear program contents:

Press C (clear) on the remote control unit.

To specify the first track to be programmed:

Only the track to be played first can be specified.

- 1 Press EDIT.
- 2 Select the desired track by pressing SKIP ◀◀ or ▶▶.
- 3 Set the playing time with the digit buttons.

If the specified time is too short for any track to be programmed:

Programming cannot be performed.

NOTES:

- With discs contained 33 tracks or more, programming may not be correctly performed.
- With Compu Program Edit function, the programmed total playing time is not occasionally close to the specified time compared with Auto Program Edit.
- With LD discs, chapter No. 0 will not be programmed.
- With LD discs, when chapter No. 1 is programmed, the programmed total playing time may slightly differ from the actual calculation. This is not a malfunction.

EXTRA PLAYBACK (CAV discs only)

Still frame and Frame-by-Frame advance function

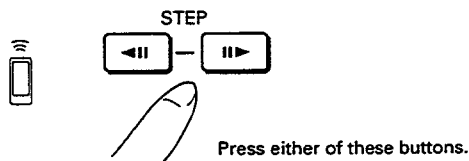

During playback if STEP (◀|| or ||▶) on the remote control unit is pressed, the picture will be frozen. At this point, the disc can be played one frame at a time in either the forward or reverse direction by pressing one of these buttons. The sound is muted during still frame or frame advance operation.

To return to normal operation, press PLAY ▶.

Use frame advance to watch pictures one frame at a time

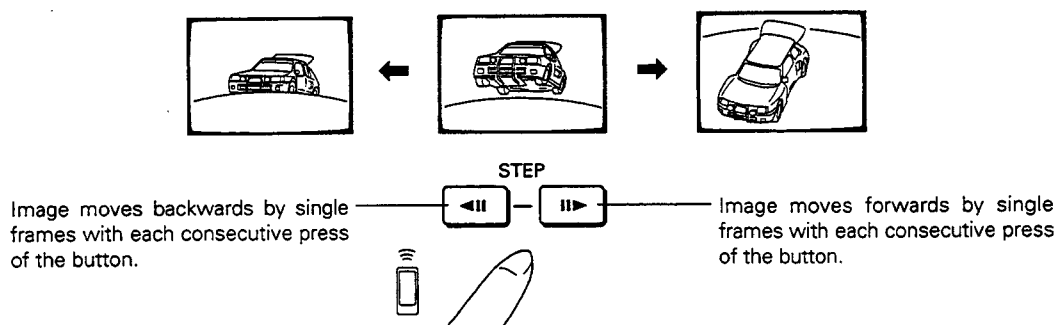

- Press PLAY ▶ to return to normal playback.
- Sound cannot be heard during still or frame playback.

To vary the playback direction or speed

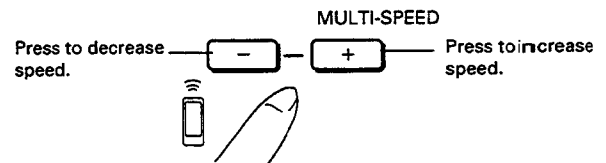
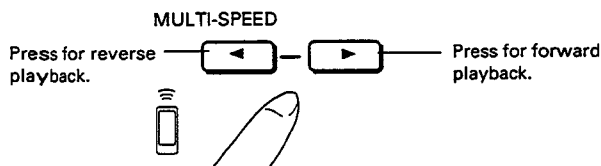

During playback, the playback direction can be changed with MULTI-SPEED. 1/4 the normal playback speed is set automatically.

With + and - buttons, the playback speed can be changed from x3 to 1/90 the normal playback speed.

Sound is muted during Multi-speed playback operation. To return to normal playback operation, press PLAY ▶.

- The selected speed is displayed by pressing DISPLAY.

Speed display	Speed
x3	3 times the normal playback speed.
x2	Twice the normal playback speed.
x1	Normal playback speed.
1/2	1/2 the normal playback speed.
1/4	1/4 the normal playback speed.
1/8	1/8 the normal playback speed.
1/16	1/16 the normal playback speed.
1/30	1/30 the normal playback speed.
1/90	1/90 the normal playback speed.

Faster
↑
↓
Slower

If playback automatically switches to still frame display mode.

If a disc containing special signals called "picture stop codes" is played at x1, 1/2, 1/4, 1/8, 1/16, 1/30, or 1/90 speed, playback pauses automatically whenever the unit encounters a frame where a picture stop code is encoded, and the still picture of that frame is displayed on the monitor screen. To move from that position, press PLAY ▶ or MULTI-SPEED ◀/▶.

By pressing ▶/|| for approx. 2 sec., "PSC ON" displays on the screen. At the point where the stop code is recorded without stopping, the viewing can be continued. One more time, press ▶/|| for more than 2 sec., and "PCS OFF" displays on the screen. When a picture stop code is encountered, the screen becomes still.

NOTE:

With CLV discs, Still Frame, Frame-by-Frame advance and Multi Speed function cannot be carried out. If STEP or MULTI-SPEED is pressed during playback of a CLV disc, warning message "CLV" appears on the monitor screen for about 2 seconds.

DISPLAY SWITCHING

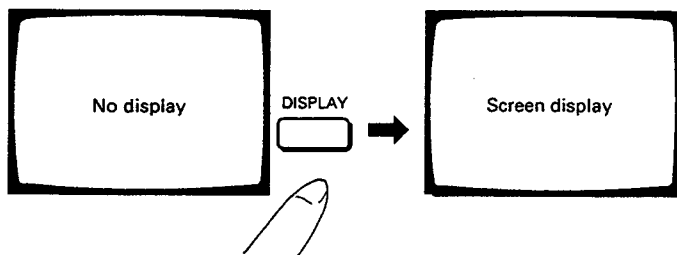

Information regarding the operations being carried out can be displayed on the screen of the monitor TV. When DISPLAY is pressed the first time, the screen display appears.

With LD discs containing a TOC ...

Each time DISPLAY is pressed, the display changes in the following order: time/frame number (elapsed play time/frame from the beginning of the disc) → Remain Time ALL (remaining play time of the disc) → Total Time (total play time of the disc) → display off.

- With CAV discs, the Disc time ABS (elapsed play time from the beginning of the disc) is displayed after the frame number.

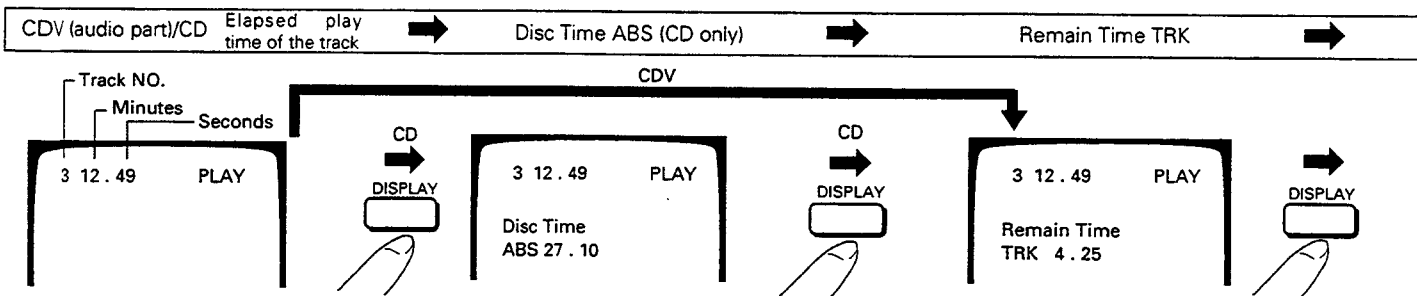
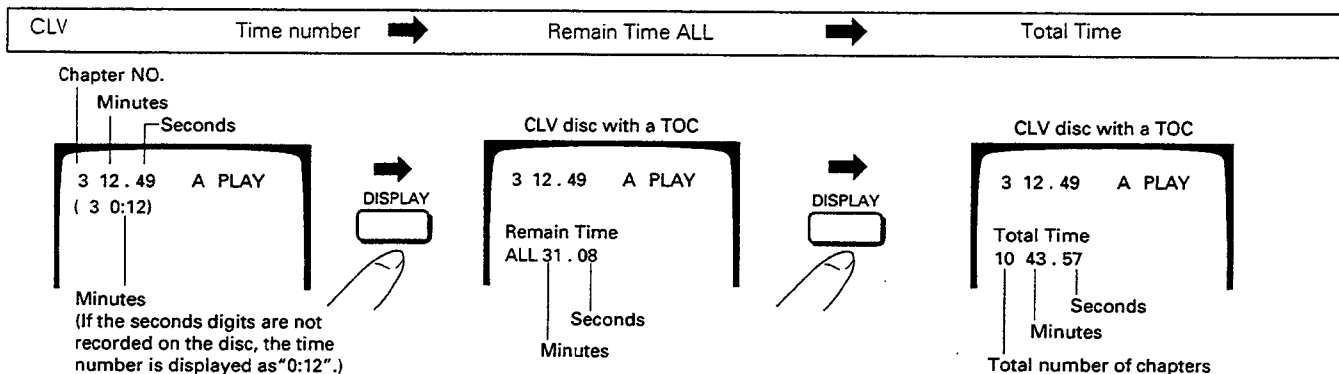

Other displays

Lights - Flashes	Function	Lights - Flashes	Function
OPEN	Opening of the table	Random	Random play
CLOSE	Closing of the table	Pgm. Rnd	Program random play
STOP	Stop mode	Editing	Edit mode
PLAY	Play mode	Auto	Auto program edit
PAUSE	Pause mode	Compu	Compu program edit
STILL	Frozen picture	Hilite	Hilite scan mode
1/2, 1/4...	Slow-speed play	Intro	Intro scan mode
x2, x3	High-speed play	Digital	Digital signal setting
CLV	CLV play	Analog	Analog signal setting
A	Side A play	Stereo	Stereo
B	Side B play	1/Lch	Main audio/Left channel
Repeat Memory	Memory repeat	2/Rch	Sub audio/Right channel
Repeat A-B	A-B repeat	CX ON	CX noise reduction system ON
Repeat Side -A (B)	One side repeat	CX OFF	CX noise reduction system OFF
Repeat All	Two-side repeat	Last Memory	Last memory
Repeat Chapter (Track)	Chapter/track repeat	A ▶ B	Changing from disc sides A to B
Repeat Random	Random repeat play	B ▶ A	Changing from disc sides B to A
Repeat Program	Program repeat	Output Level	Digital level control
Program	Program mode	PSC ON	Picture stop cancel function ON
Step-	Chapter/Track program step	PSC OFF	Picture stop cancel function OFF

With LD discs not containing a TOC...

Each time DISPLAY is pressed, the display changes in the following order: time/frame number → display off.

With CDV discs...

Each time DISPLAY is pressed, the display changes in the following order: elapsed play time of the track being played → Remain Time TRK (remaining play time of the track being played) → Remain Time ALL (remaining play time of the video or audio part being played) → Total Time (total play time from the beginning of the video or audio part being played) → display off.

With CD discs ...

Each time DISPLAY is pressed, the display changes in the following order: elapsed play time of the track being played → Disc Time ABS (elapsed play time from the beginning of the disc) → Remain Time TRK (remaining play time of the track being played) → Remain Time ALL (remaining play time of the disc) → Total Time (total play time from the beginning of the disc) → display off.

- These data are also displayed in the display window of the front panel.

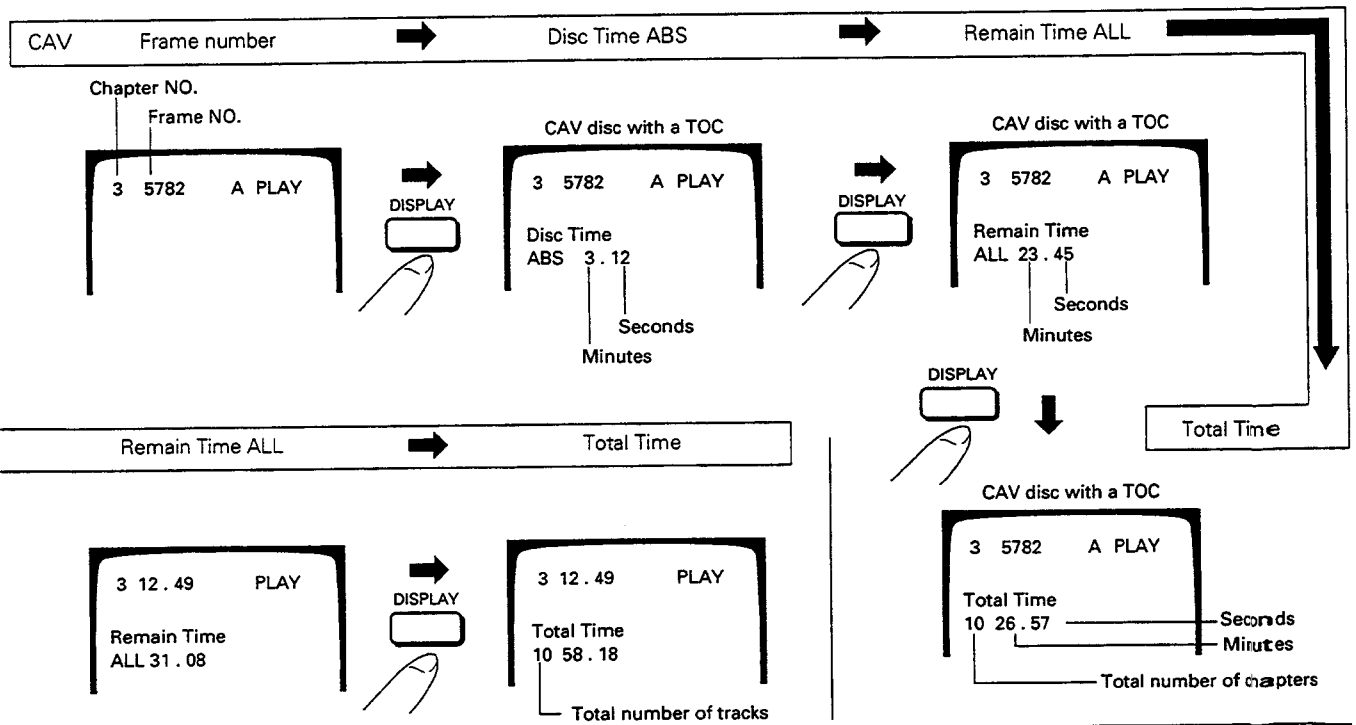

Audio output level meter display:

During elapsed play time of the track mode of CD playback or CDV (audio part) playback, the audio output level meter will be displayed on the monitor screen.

NOTE:

In some cases, the displayed output level may differ from the actual output level, but this is not a malfunction.

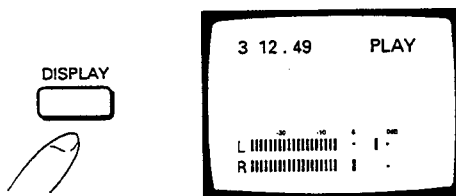

NOTES:

- When the Direct CD function (See page 22) is activated, the player does not display information on the monitor screen.
- Information cannot be displayed during use of the film mode.

TROUBLESHOOTING

Incorrect operations are often for trouble and malfunctions. If you think that there is something wrong with this component, check the points below. Sometimes the trouble may lie in another component. Inspect the other components and electrical appliances being used. If the trouble cannot be rectified even after exercising the checks listed below, ask your nearest PIONEER authorized service center or your dealer to carry out repair work.

SYMPTOM	CAUSE	REMEDY
1. Disc table is not ejected when ▲ is pressed.	<ul style="list-style-type: none"> ● Power cord is not properly plugged into AC wall socket. ● Power switch is not turned on. 	<ul style="list-style-type: none"> ● Plug in power cord. ● Turn on power switch.
2. Disc table comes out.	<ul style="list-style-type: none"> ● Disc is dirty. ● The disc is not properly set on the disc table. ● Moisture has condensed on parts in the player. ● Disc is warped. 	<ul style="list-style-type: none"> ● Clean disc. ● Set the disc properly. ● Remove disc and let player stand for 1 to 2 hours until it is dry. ● Try to alleviate the warp. (Refer to Symptom 7, remedy column.)
3. Remote control does not work.	<ul style="list-style-type: none"> ● The CONTROL IN terminal on the rear panel is connected to Pioneer projection monitor or AV amplifier. ● Batteries are weak. ● There is an obstacle between the player and the remote control unit. ● Remote control unit is not in a good location for transmission. 	<ul style="list-style-type: none"> ● Aim the remote control unit at the projection monitor or AV amplifier. ● Replace batteries. ● Remove the obstacle or shift the remote control position. ● Operate the remote control unit in front of the player.
4. Operation of the remote control unit causes the TV to operate improperly.	<ul style="list-style-type: none"> ● Some TV sets have remote control functions that operate improperly in response to the remote control unit of the player. 	<ul style="list-style-type: none"> ● Move the TV and the player further apart, or cover the remote sensor of the TV during disc playback.

Abnormal functioning of this unit may be caused by lightning, static electricity, or other external interference. To restore normal operation, unplug the AC power cord and then plug it in again.

WHEN A LASERVISION DISC IS BEING PLAYED

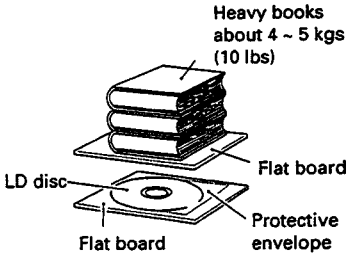
SYMPTOM	CAUSE	REMEDY
5. Disc is rotating but there is no picture.	<ul style="list-style-type: none"> • The TV set is not turned on. • Wrong connections from player to TV. 	<ul style="list-style-type: none"> • Turn on TV. • Make correct connections.
6. Picture continuously moves vertically.	<ul style="list-style-type: none"> • The TV vertical hold control is not adjusted properly. 	<ul style="list-style-type: none"> • Adjust vertical-hold control on TV.
7. Particular disc does not playback properly. The playback stops in the middle of the disc program.	<ul style="list-style-type: none"> • The playing surface of the disc is dirty. • The disc is warped. 	<ul style="list-style-type: none"> • Use a soft cloth and lightly wipe off the dirt from the surface of the disc. If necessary, moisten a cloth with diluted neutral detergent to remove heavy dirt or fingerprints. • LD discs only Put the disc into the protective envelope, then place it on a flat desk top. Subsequently, place a flat board on the disc, and load it with about 4 ~ 5 kgs (about 10 lbs). If it is left in this state for one day, sometimes the warp will alleviated. 
8. Sound is unnatural or distorted.	<ul style="list-style-type: none"> • CX system is turned ON for disc which has no <input type="checkbox"/> mark. 	<ul style="list-style-type: none"> • Press D/A/CX to turn CX system OFF.
9. No sound output during playback.	<ul style="list-style-type: none"> • MULTI-SPEED or STILL/STEP playback is being performed. Sound is output only during the normal play mode. The audio signals are not output during other playback modes. 	<ul style="list-style-type: none"> • Press PLAY ► to set the player to normal play mode.
10. During STILL playback, a part of the screen image shakes.	_____	<ul style="list-style-type: none"> • Even if the disc is a standard play disc, there may be some cases in which a fully still image cannot be obtained, but this does not mean that the player or the disc is defective.
11. CHAPTER SKIP, CHAPTER PROGRAM PLAY and CHAPTER NUMBER SEARCH cannot be performed.	<ul style="list-style-type: none"> • Disc in which no chapter numbers are recorded is loaded. 	<ul style="list-style-type: none"> • Press DISPLAY to check if chapter number is displayed.
12. Certain discs take too long to search or are not searched.	<ul style="list-style-type: none"> • It takes time to read the recorded code, depending on the disc. 	<ul style="list-style-type: none"> • Press C (clear) and picture will appear. (At this point, a slightly different scene from that which has been searched for may appear.)

TROUBLESHOOTING

SYMPTOM	CAUSE	REMEDY
13. Certain discs take too long to start or do not start.	<ul style="list-style-type: none"> There are errors when the disc code is read (There is no damage to the unit). 	<ul style="list-style-type: none"> Press ■ and stop the playback. Press PLAY ► and start the playback again. (Repeat this operation a few times.)
14. The player takes too long to find point A during A-B (INTERVAL) REPEAT operation.	<ul style="list-style-type: none"> Same as item 12 above. 	<ul style="list-style-type: none"> Same as item 12 above. (The repeat mode is cancelled).
15. Picture other than instructed is searched in TIME NUMBER SEARCH mode.	<ul style="list-style-type: none"> Method of inputting numerals in the TIME NUMBER SEARCH mode differs, depending on whether time number is recorded on disc in hours and minutes or minutes and seconds, as shown below: [e.g.] 12-minute search Disc in which time number is recorded in hours and minutes <div style="text-align: center; margin: 10px 0;"> <p style="margin: 0;">CHP/TM 1 2 PLAY</p> <p style="margin: 0; text-align: center;">"minutes"</p> </div> <ul style="list-style-type: none"> Disc in which time number is recorded in minutes and seconds <div style="text-align: center; margin: 10px 0;"> <p style="margin: 0;">CHP/TM 1 2 0 0 PLAY</p> <p style="margin: 0; text-align: center;">"minutes" "seconds"</p> </div>	

WHEN PLAYING BACK A COMPACT DISC

SYMPTOM	CAUSE	REMEDY
16. Player stops immediately after playback is started.	<ul style="list-style-type: none"> Disc is loaded upside down (CD, CDV, onesided LD discs). The playing surface of the disc is dirty. Disc is not properly set on the disc table. 	<ul style="list-style-type: none"> Load the disc correctly with the label side upward. Use a soft cloth and lightly wipe off the dirt from the surface of the disc. If necessary, moisten a cloth with diluted neutral detergent to remove heavy dirt or fingerprints. Set the disc properly.
17. No sound output	<ul style="list-style-type: none"> The stereo amplifier is not correctly connected. You are not operating the stereo amplifier correctly. The connection terminals and/or the plugs of the connection cords are dirty. The plugs of the connection cords are disconnected, or are not fully pushed in. The player is in pause mode. 	<ul style="list-style-type: none"> Connect the amplifier correctly. Refer to the operating instructions for the amplifier, and operate the amplifier correctly. Clean the plugs and terminals and connect again. Make sure that connections are made correctly. Press PLAY ► and restore the player to play mode.
18. Sound is distorted.	<ul style="list-style-type: none"> The audio output jacks are connected to the PHONO jacks. The connection terminals and/or the plugs of the connection cords are dirty. The plugs of the connection cords are not fully pushed in. 	<ul style="list-style-type: none"> Connect to the AUX, CD, VDP, LD or VCR jacks. Clean the plugs and terminals and connect again. Push the plug in firmly.

SPECIFICATIONS

1. General

System LaserVision Disc system and
Compact Disc digital audio system
Laser Semiconductor laser wavelength 780 nm
Power requirements
U.S. and Canadian models AC 120 V, 60 Hz
Other models AC 110 - 127 V/220 - 240 V,
(switchable) 50/60 Hz
Power consumption 40 W
Weight 8.0 kg (17 lbs 10 oz)
Dimensions 420 (W) x 434 (D) x 140 (H) mm
16-9/16 (W) x 17-1/16 (D) x 5-1/2 (H) in
Operating temperature +5°C ~ +35°C
(41°F - 95°F)
Operating humidity 5% ~ 85%
(There should be no condensation of moisture.)

2. Disc

LaserVision Discs

*Maximum playing times
12-inch standard play disc 1 hour/both sides
12-inch extended play disc 2 hours/both sides
8-inch standard play disc 28 min/both sides
14 min/one side
8-inch extended play disc 40 min/both sides
20 min/one side
Spindle motor speed
Standard play disc 1,800 rpm
Extended play disc 1,800 rpm (inner circumference)
to 600 rpm (outer circumference)
(For a 12-inch disc)

Compact Discs

DISC Diameter: 5-inch, 3-inch, Thickness: 1.2 mm
Rotation direction (pickup side) Counterclockwise
Linear speed 1.2 ~ 1.4m/sec
*Maximum playing time 74 min. 5-inch discs
20 min. 3-inch discs
(For stereo playback)

Compact Discs with Video

Disc Diameter: 5-inch, Thickness: 1.2 mm
Rotation direction (pickup side) Counterclockwise
Linear speed Audio portion: 1.2 ~ 1.4m/sec
Video portion: 11 ~ 12m/sec
*Maximum playing time Video portion: 5 min. (CLV)
Audio portion: 20 min. (Digital)

* Actual playback time differs for each disc.

3. Video characteristics (two pairs)

Format NTSC specifications
Video output
Level 1 Vp-p nominal, sync. negative, terminated
Impedance 75Ω unbalanced
Jack RCA jack

4. S-Video output (CLD-D570 : two pairs)

Y (luminance) - Output level 1 Vp-p (75 Ω)
C (color) - Output level 286 mVp-p (75 Ω)
Jack S-VIDEO jack

5. Audio characteristics (two pairs)

Output level
During analog audio output 200 mVrms
(1 kHz, 40%)
During digital audio output 200 mVrms
(1 kHz, -20 dB)
Jacks Both RCA jacks

Digital Audio Characteristics

Frequency response	4 Hz - 20 kHz (EIAJ)
SN ratio	115 dB (EIAJ)
Dynamic range	98 dB (EIAJ)
Total harmonic distortion	0.0025% (EIAJ)
Wow and flutter	Limit of measurement (EIAJ)

6. Other Terminals

Control input/output Both miniature jacks
CD-DECK synchro Miniature jacks
Optical digital output Optical digital jack
(except for U.S. and Canadian models)

7. Accessories

Remote control unit 1
Size "AAA" (IEC R03) dry cell batteries 2
Video cord 1
Audio cord 1
Operating instructions 1
Warranty card 1

SPECIFICATIONS

8. Functions

	Function	Standard play Disc (CAV)	Extended play Disc (CLV)	Compact Disc with Video	Compact Disc
Basic Functions	Two-side play	YES	YES	NO	NO
	Single-side play	YES	YES	YES	YES
	Pause	YES	YES	YES	YES
	Stop	YES	YES	YES	YES
Search	Fast forward (forward and reverse)	YES	YES	YES	YES
	Chapter/Track skip	YES	YES	YES	YES
	Direct chapter/Track number search	YES	YES	YES	YES
	Frame number search	YES	NO	NO	NO
	Time number search	NO	YES	YES	YES
	Absolute time search	NO	NO	NO	YES
Program	Chapter/Track program play	YES	YES	YES	YES
	Program correction	YES	YES	YES	YES
Repeat	Repeat between 2 points	YES	YES	YES	YES
	Memory repeat	YES	YES	YES	YES
	Chapter/Track repeat	YES	YES	YES	YES
	One-side repeat	YES	YES	YES	YES
	Two-side repeat	YES	YES	NO	NO
	Program repeat	YES	YES	YES	YES
	Random repeat	YES*1	YES*1	YES	YES
	Program random repeat	YES	YES	YES	YES
Trick play	Still/Step	YES	NO	NO	NO
	Multi-speed (Forward/reverse 9-level variable)	YES	NO	NO	NO
Time display	Elapsed time display	NO	YES	YES	YES
	Absolute time display	YES*1	NO	NO	YES
	Remaining track time display	NO	NO	YES	YES
	Remaining total time display	YES*1	YES*1	YES	YES
	Total number of selections, total time display	YES*1	YES*1	YES	YES
Others	Compu program/Auto program edit	YES*1	YES*1	YES	YES
	Hi-Lite scan	NO	NO	YES*4	YES
	Intro scan	YES	YES	YES*5	NO
	CX system ON/OFF	YES*2	YES*2	NO	NO
	Auto Digital/Analog switch	YES*3	YES*3	NO	NO
	Audio channel selection (Stereo, 1/L, 2/R)	YES	YES	YES	YES
	Digital level control	YES*3	YES*3	YES	YES

*1 Only discs with TOC

*2 Valid for analog audio playing a disc with the  mark.

*3 Can only be used with discs with digital audio tracks.

*4 Audio part only

*5 Video part only

NOTE:

The specifications and design of this product are subject to change without notice, due to improvements.

OTHER FUNCTIONS

- Display ON/OFF, Visual Calendar Display
- Random Playback
- Digital Audio for LaserVision Discs
- Last Memory
- Direct CD

LaserDisc is a trademark of Pioneer Electronic Corporation.

Published by Pioneer Electronic Corporation.
Copyright © 1994 Pioneer Electronic Corporation.
All rights reserved.

PIONEER ELECTRONIC CORPORATION 4-1, Meguro 1-Chome, Meguro-ku, Tokyo 153, Japan

PIONEER ELECTRONICS [USA] INC. 2265 East 220th Street, Long Beach, California 90810, U.S.A.

P.O. BOX 1720, Long Beach, California 90801, U.S.A.

PIONEER ELECTRONICS OF CANADA, INC. 300 Allstate Parkway Markham, Ontario L3R 0P2, Canada

PIONEER ELECTRONIC [EUROPE] N.V. Haven 1087 Keetberglaan 1, 9120 Melsele, Belgium, TEL: 03/750.05.11

PIONEER ELECTRONICS AUSTRALIA PTY. LTD. 178-184 Boundary Road, Braeside, Victoria 3195, Australia, TEL: [03] 580-9911